

EQUINOX[®]

700 | 900

Instruction Manual

POWERED BY **Multi-IQ**
Simultaneous Multi-Frequency Technology

MINELAB

Contents

Getting Started

Quick Start	5
Parts Overview	6
Care of Parts	6
Screen Protector Application	6
Controls	7
Display	8
Introduction to Search Modes	9
Choosing the Right Search Mode	9
Reset a Profile	9

Search Modes

Park	11
Field	12
Beach	13
Gold*	14

General Settings

Global and Local Settings	16
Frequency	17
Changing the Frequency	17
Multi-IQ Operation	17
Single Frequency Operation	17
Frequencies and Search Modes	17
Sensitivity	18
Adjust the Sensitivity Level	18
Depth Gauge	19
Lighting	20
Backlight	20
Flashlight	20
Vibration	21
Turning Master Vibration On/Off	21
Turning Tone Region Vibration On/Off	21
User Profile*	22
Save a User Profile	22
Turn the User Profile On/Off	22

Settings Menu

Settings Menu Navigation	24
Settings Menu Navigation	24
Accessing Advanced Settings	24
Noise Cancel	25
Auto Noise Cancel	25
Manual Noise Cancel*	26
Continuous Auto Noise Cancel	26
Ground Balance	27
Auto Ground Balance	27
Manual Ground Balance	28
Tracking Ground Balance	28
Volume Adjust	29
Adjust the Volume	29
Tone Volume (Advanced Setting)	30
Adjust Tone Volume	30
Threshold Level	31
Adjust the Threshold Level	31
'Reference' Threshold Tone	31
'True' Threshold Tone	32
Threshold Pitch* (Advanced Setting)	33
Adjust the Threshold Pitch	33
Target Tone	34
Choosing a Target Tone Setting	34
Change the Number of Target Tones	34
Tone Pitch (Advanced Setting)	35
Adjust Tone Pitch – 1, 2, or 5 Tones	35
Adjust Tone Pitch – All Tones	36
Accept/Reject	37
Creating a Discrimination Pattern	37
Accept or Reject Targets Upon Detection	37
All Metal	37
Tone Break (Advanced Setting)	38
Adjust Tone Break	38
Recovery Speed	39
Adjust Recovery Speed	39
Swing Rate	39
Iron Bias (Advanced Setting)	40
How Iron Bias Works	40
Choosing an Iron Bias Setting	40
Adjust the Iron Bias	40

* EQUINOX 900 only

Contents *(Continued)*

Target Identification, Pinpointing & Recovery

Target Identification	42
Target Identification Number.....	42
Discrimination Scale.....	42
Pinpoint	43
Pinpoint Mode Visualisation.....	43
Locate a Target Using Pinpoint Mode.....	43
Locate a Target Manually.....	44

Headphones, Batteries & Charging

Wireless Headphones	46
ML 85 Wireless Headphones.....	46
Pair Wireless Headphones.....	46
Re-connect Previously Paired Headphones.....	46
Wireless Audio Indicator.....	46
Wired Headphones	47
Connect Wired Headphones.....	47
Connect Waterproof Headphones.....	47
Headphone Socket Submersion.....	47
Batteries and Charging	48
Charger Information and Safety.....	48
Charging the Battery.....	48
Battery Level Indication.....	49
Operating With a Power Bank.....	49
Battery Maintenance.....	49

Errors & Troubleshooting

Error Codes	51
Coil Disconnect Error.....	51
System Error.....	51
Critically Low Battery Error.....	51
General Troubleshooting	52

Safety, Care and Maintenance

Detector Care and Safety	55
General Care and Safety.....	55
Maintenance of Parts.....	56

Specifications, Presets & Compliance

Technical Specifications	58
Default Settings	59
Factory Reset	61

⚠ CAUTION

Before assembling, charging, or using your detector for the first time, read the warnings and safety information listed in the following sections:

- ▶ **"Charger Information and Safety" (page 48)**
- ▶ **"General Care and Safety" (page 55)**

* EQUINOX 900 only

Getting Started

Quick Start



Before first use, it is recommended that you fully charge the battery for 6 hours (page 48).

1

TURN ON

Press the Power button on the side of the control panel.

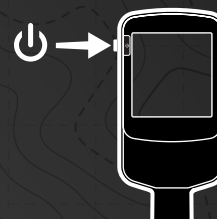

2

SELECT A SEARCH MODE

Select a Search Mode that suits your detecting location and desired target type.

See "Introduction to Search Modes" on page 9 for more information on how to choose the most suitable Search Mode.



3

NOISE CANCEL

Select Noise Cancel from the Settings Menu, then press  to initiate an Auto Noise Cancel. This will take approximately 5 seconds to complete.



4

GO DETECTING

Press  to return to the Detect Screen, and begin detecting!



If there is excessive ground noise after completing the Quick Start steps, perform Ground Balance (page 28).
If excessive noise is still being experienced, try reducing the Sensitivity level a little (page 18).

* EQUINOX 900 only

Parts Overview

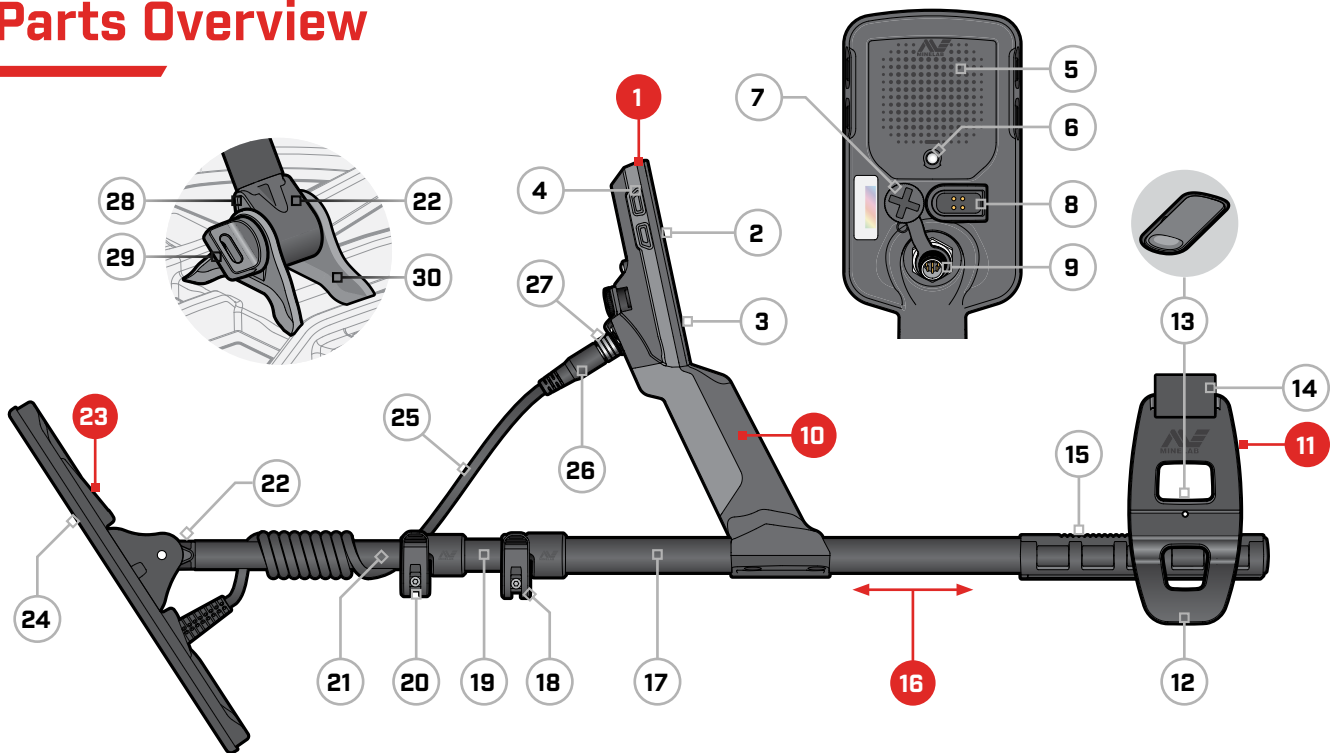

1. Control Pod

- 2. Display
- 3. Keypad
- 4. Side Buttons (×3/×4*)
- 5. Speaker
- 6. Flashlight
- 7. Headphone Socket 3.5 mm/1/8" (with waterproof dust-cap)
- 8. Charging Interface
- 9. Coil Connector Interface

10. Handgrip

with vibration and internal Lithium-ion Rechargeable Battery

11. Armrest

- 12. Stand
- 13. Armrest Lock
- 14. Armstrap
- 15. Armrest Rail

16. Shafts

- 17. Upper Shaft
- 18. Upper Camlock
- 19. Middle Shaft
- 20. Lower Camlock
- 21. Lower Shaft
- 22. Shaft Yoke

23. Coil (with cable)

- 24. Skidplate
- 25. Coil Cable
- 26. Coil Connector
- 27. Retaining Ring
- 28. Teardrop Washers (×2)
- 29. Coil Bolt
- 30. Yoke Bracket

* EQUINOX 900 only

CARE OF PARTS

The parts shown require periodic maintenance and care throughout the detector's life to maintain good working condition. Carefully read and follow all instructions listed in "General Care and Safety" on page 55 before using the detector or carrying out cleaning or maintenance on any parts.

⚠ Do not use any lubricants, sealants, or solvent or alcohol-based cleaners on any part of your detector. Even chemicals typically considered mild such as isopropyl alcohol or silicone lubricants can degrade material properties or the integrity of seals. Use of chemicals on the product may void the warranty.

SCREEN PROTECTOR APPLICATION

Applying a screen protector will protect your screen against scuffing and scratching from normal use.

1. Remove the thin plastic film from the detector screen. Make sure the screen is free of dust and fingerprints.
2. Peel the backing off of the screen protector, being careful not to touch the adhesive side.
3. Hold the edges of the screen protector, align it to the screen, and apply gently.
4. Wipe any bubbles to the edge with a soft, clean cloth.
5. Peel off the front layer.

Controls



1. Charge Status LED

Shows the charge status of the detector battery (page 48).

2. Power

Turns the detector On/Off.

Long-press (7 seconds) from Off to restore factory settings (page 61).

3. Backlight

Selects the Backlight brightness (page 20).

Long-press (2 seconds) to turn the Flashlight On/Off (page 20).

4. Search Mode

Selects the next available Search Mode (page 9).

Long-press (5 seconds) to reset the current Search Mode Profile's local settings to their factory presets (page 9).

5. All Metal

Toggles between the current discrimination pattern and All Metal to accept all targets (page 37).

6. Pinpoint/Detect

Press from the Settings Menu to return to the Detect Screen.

Press from the Detect Screen to activate Pinpoint (page 43). Press again to deactivate Pinpoint.

7. Frequency

Scroll through the available frequencies (kHz): 4, 5, 10, 15, 20*, 40* and Multi-IQ (page 17).

8. Accept/Reject

Accepts or Rejects targets by turning On/Off individual Discrimination Segments (page 37).

Use to create discrimination patterns (page 37) and to adjust Tone Regions* via the Settings Menu.

9. Minus/Plus

Press when in the Detect Screen to adjust the Sensitivity level (page 18).

Press when in the Settings Menu to adjust the value of the selected setting.

10. Settings

Press to access and scroll through the Settings Menu.

Long-press (2 seconds) from the Settings Menu to access Advanced Settings where available.

11. User Profile*

Press to turn the saved User Profile On/Off (page 22).

Long-press (2 seconds) to store the current Search Mode settings to the Custom Search Mode (page 22).

12. Wireless Audio

Turns Wireless Audio On/Off (page 46).

Long-press (2 seconds) to initiate Wireless pairing mode to connect new headphones (page 46).

* EQUINOX 900 only

Display

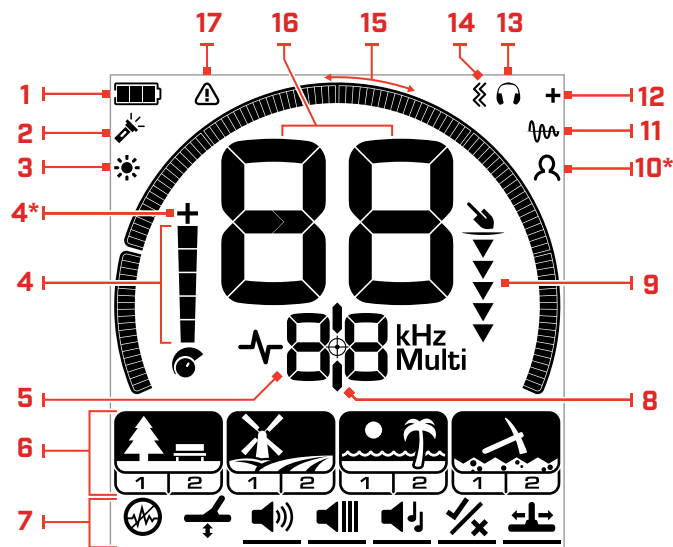

1. Battery Level/Charging

Indicates the current battery level (page 48).

2. Flashlight Indicator

Indicates that the Flashlight is On (page 20).

3. Backlight Indicator

Indicates that the backlight is On (page 20).

4. Sensitivity Level

Displays the Sensitivity level (page 18).

5. Frequency Display

Shows the current operating Frequency (page 17).

Also shows Error Codes (page 51), and indicates the current active Advanced setting.

6. Search Modes

Displays the Search Mode: Park, Field, Beach and Gold*.

Each Search Mode has 2 customisable Profiles (page 9).

Search Mode



Profile

Setting



Advanced Setting

7. Settings Menu

A menu of all Settings and Advanced Settings (page 23).

8. Pinpoint Indicator

Indicates that Pinpoint is turned On (page 43).

9. Depth Gauge

Shows the approximate depth of a detected target (page 19).

10. User Profile*

Indicates that the saved User Profile is active (page 22).

11. Tracking Ground Balance Indicator

Indicates that Tracking Ground Balance is turned On (page 28).

12. Wireless Audio Indicator

Indicates that Wireless Audio is On (page 46).

13. Headphones Indicator

Indicates that headphones are connected to the detector (either wireless or wired) (page 47).

14. Vibration Indicator

Indicates that handle Vibration is On (page 21).

15. Discrimination Scale

Represents each Target Identification Number as a segment on a scale. Segments can be turned On/Off to create a Discrimination Pattern (page 37 and page 17).

High resolution 119 segment [-19 to 99] Discrimination Scale for accurate, stable target identification (page 58).

Shows visualisation of target signal strength when in Pinpoint Mode (page 43).

Also used when adjusting Tone Regions for advanced audio settings.

16. Target Identification Display

A numerical value (from -19 to 99) is assigned to each detected target based on its conductive or ferrous properties. This allows objects to be identified before digging. For example, a US quarter will typically have a Target ID Number of 89 (page 42).

Negative numbers are ferrous, positive numbers are non-ferrous from fine gold (low ID's) to large silver (high ID's).

17. Beach Overload Indicator

Indicates an automatically reduced transmit signal strength when in Beach Mode. This prevents overload due to extreme conditions.

* EQUINOX 900 only

Introduction to Search Modes

CHOOSING THE RIGHT SEARCH MODE

The EQUINOX 700 and 900 have preset Search Modes that have unique target separation and depth abilities. Choosing the right Search Mode is important to get the best performance for the environment you are detecting in.

Each mode represents a common detecting use: Park, Field, Beach, and Gold*. Each Search Mode has two Profiles, uniquely pre-configured to optimise the detector for the best performance in the conditions typical to that location. Each of the Profiles can be modified and saved.

Select a Search Mode and Profile



Press the Search Mode button to select the next Search Mode.

Choose the Search Mode that best matches your detecting location – Park, Field, Beach, or Gold*.

To further optimise the preset detector settings, choose the best Search Profile for your detecting conditions:

- **Search Profile 1** is suitable for general conditions.
- **Search Profile 2** is optimised for more difficult conditions. Target sensitivity is enhanced, but extra noise may also result.

Park

Great for high-trash recreational areas, including most general detecting.

More on [page 11](#).



Profile 1

General and Coins

Profile 2

Fine Jewellery

Field

Ideal for detecting in historical fields for the widest range of target sizes.

More on [page 12](#).



Profile 1

Coins and Artefacts

Profile 2

Fine Coins and Artefacts

Beach

For all salty conditions; dry sand, wet sand, surf and underwater.

More on [page 13](#).



Profile 1

Dry and Wet Sand

Profile 2

Underwater and Surf

Gold*

For gold nugget prospecting in mineralised goldfield locations.

More on [page 14](#).



Profile 1

Normal Ground

Profile 2

Difficult Ground

* EQUINOX 900 only

RESET A PROFILE

Individual Search Profiles can easily be returned to their factory preset settings:

- only the local settings will be reset
- any global settings will remain in their last-use state

1. Press the Search Mode button to navigate to the Profile you want to reset.
2. Press-and-hold the Search Mode button until 'SP' appears on the Target ID Display.

SP

'SP' will appear on the Target ID Display when a Search Mode Profile is reset.

Search Modes

Park

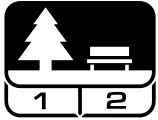

Great for high-trash recreational areas, including most general detecting.

Park Mode is designed for searching in urban parks or other recently inhabited sites where there may be coins and jewellery. There is often also lots of metallic litter including aluminium foil, pull tabs and bottle caps.

Park Mode is a good starting point for other general uses such as freshwater detecting.

Park Mode default settings provide great depth, accurate target identification and good discrimination in trash-infested areas typical of recreational parks. With Frequency set to Multi, Park Mode will be the most sensitive of all of the modes to a wide range of targets, while rejecting much of the trash. If in doubt in a new area or when first detecting, try Park mode first.

Park Profile 1: General and Coins

Park 1 is optimised for modern coins and larger jewellery with a default discrimination pattern set to reject many common aluminium foil-like targets. Therefore this is the ideal Profile to start with to learn EQUINOX before experimenting with the other Modes and more specialist settings.

Park 1 Multi-IQ processes a lower frequency weighting of the multi-frequency signal, as well as using algorithms that maximise ground balancing for soil to achieve the best signal-to-noise ratio. Hence Park 1 is most suited for general detecting and coin hunting.

Park Profile 2: Fine Jewellery

Park 2 is ideal for smaller targets in trash-infested (including ferrous trash) locations. It will detect a wider range of targets including low conductor (or higher frequency) targets, e.g. fine jewellery. All non-ferrous targets are accepted by default. Recovery Speed is increased to clearly identify good targets masked by iron trash.

Target Tone is set to All Tones (At) (page 34) to provide as much target information as possible via audio. Park 2 Multi-IQ processes a higher frequency weighted multi-frequency signal while ground balancing for soil.

Park Detecting Hotspots

Detect in areas where people gather, such as near park benches, under trees and other shady spots where people have been sitting, or at recreation grounds near clubrooms or spectator stands.

After festivals or events, there are often many objects to find, especially coins, however but you may be in competition with other detectorists.

Always make sure you are allowed to detect in public parks, recreation areas and on private property.

Difficult Park Areas – Aluminium Foil

Modern parks typically contain a lot of aluminium shards from discarded trash (e.g. drink cans, pull tabs, ring pulls, etc.) Because aluminium is a non-ferrous very low conductive target, its Target ID falls within the same range as fine jewellery.

To dig less aluminium foil while still finding fine jewellery, use Park 1 which rejects Target IDs 1 and 2. Reject higher adjacent ID's if the aluminium trash is larger in size.

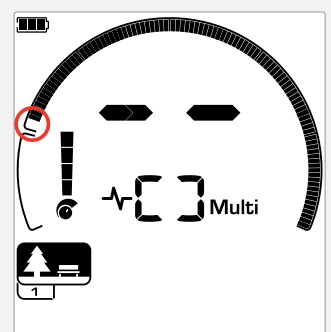

Reject Target IDs 1 and 2 in the discrimination pattern for Park Mode Search Profiles.

Field



Ideal for detecting in historical fields for the widest range of target sizes.

Field Mode is for searching open pasture, cropped or ploughed fields and historically occupied sites. These environments generally contain ferrous trash and coke from previous human occupation. In highly infested sites, Field Mode is well suited for rejecting coke and detecting hammered coins and ancient artefacts amongst the iron trash.

With Frequency set to Multi, Field Mode will be the most sensitive to the widest range of targets and more accurately identify objects at the limits of detection depth, compared to all single frequency options.

Field Profile 1: Coins and Artefacts

Field 1 is for general hunting with high trash rejection. This assists in locating desired targets more easily. The default discrimination pattern is set to reject Target IDs 1 to 4 (most coke signals).

The first Tone Break is set so that Target IDs 1 to 4 will produce the same low tone as ferrous targets. Field 1 Multi-IQ processes a lower frequency weighted multi-frequency signal, as well as using algorithms that maximise ground balancing for soil, to achieve the best signal to noise ratio. Hence being most suited for general detecting and coin hunting.

Field Profile 2: Fine Coins and Artefacts

Field 2 suits locations with high target and trash densities, including ferrous trash. It will better detect small hammered coins on their edge or at greater depth. The default discrimination pattern is set to reject Target IDs 1 to 4 (most coke signals).

Target Tone is set to All Tones (At) to enhance audio identification and Recovery Speed is faster. The first Tone Break has been set so that Target IDs 1 to 4 produce the same low tone as ferrous targets. Field 2 Multi-IQ processes a higher frequency weighted multi-frequency signal while ground balancing for soil.

Field Detecting Hotspots

When it comes to detecting for historical items, you will want to find old inhabited sites that may have long disappeared from view.

Research is a great way to find out where old sites may have existed from old texts, maps, and articles. This method of site selection can pay off and yield wonderful results. Freshly ploughed fields are also very good detecting locations, as targets that were deep may have been churned to the surface during ploughing.

Difficult Field Areas – Coke

Coke is the charcoal and carbon by-product of burnt coal, and is prevalent around historically populated areas.

Generally coke has a Target ID of 1 or 2, though it can go as high as 4. For this reason it is rejected by default in Field Mode. Note that this could result in some small non-ferrous targets being missed.

Field 1 Multi-IQ, even with Target IDs 1 to 4 accepted, will reject more coke more than Field 2 using Multi-IQ.

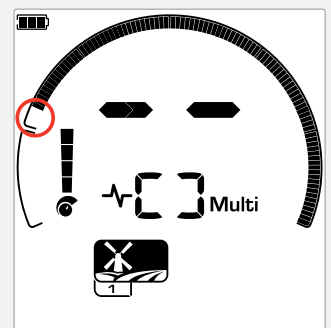

Rejected Target IDs 1 to 4 in the discrimination pattern for Field Mode Search Profiles.

Beach



Optimised for all salty conditions – dry sand, wet sand, surf, underwater.

Beach Mode is for salt water beaches including dry sand, wet sand, surf and underwater conditions. The salt that is typically present causes the sand and water to be very conductive, causing salt noise to be detected. Multi-IQ is better able to reduce this noise than any single-frequency can. Therefore Multi-IQ is the only Frequency option.

Beach Mode specifically identifies any residual salt response and assigns a Target ID of 0 (zero) – indicating that it's an unwanted target – so that desirable low conductive targets such as gold chains can readily be detected with minimal interference from the salt-water. The Recovery Speed is relatively high to further reduce unwanted salt-water signals, without greatly sacrificing detection depth.

Beach Profile 1 – Wet and Dry Sand

Beach 1 is most useful for detecting in wet and dry beach sand and also in shallow water where conductive salt signals are prevalent. It has good sensitivity to coins and small/large jewellery. Beach 1 reduces the salt signal, while maintaining high transmit power, and still being sensitive to desirable targets. Beach 1 Multi-IQ processes a low frequency weighted multi-frequency signal, and uses special algorithms to maximise ground balancing for salt.

i To maximise performance in wet sand, perform a Ground Balance (page 27) after making any changes to the Noise Cancel channel, Recovery Speed or Iron Bias.

Beach Profile 2 – Underwater and Surf

Beach 2 gives the best results when either wading or shallow diving, with the coil and/or detector fully submerged. In these instances, there is a very strong salt signal present, so Beach 2 has a lower transmit power, which results in much less noise.

This Profile may also be useful in dry conditions where there are extremely high ground noise levels. Beach 2 Multi-IQ processes a very low weighted multi-frequency combination, using the same algorithms as Beach 1 to maximise ground balancing for salt.

Beach Detecting Hotspots

Search for coins and jewellery under jetties and board-walks, beside steps and entry ways to and from the beach.

Locate the areas where people swim the most and detect in the deeper water there. Venturing into the water can give you an advantage over other detectorists who remain on the sand. Research shipwrecks if you are interested in historical finds.

Occasionally, the top layers of sand will be washed away by stormy weather conditions, exposing some deeper layers that often contain good targets.

Difficult Beach Areas – Black Sand

Some beaches contain black sand, which has high natural iron content and is often magnetic. This causes continuous false ferrous detections, making normal beach detecting impossible.

Beach Mode automatically senses black sand and reduces the transmit power to ensure that targets can still be detected without overloading occurring. When black sand is sensed, the Beach Overload Indicator will appear on the LCD. When this icon disappears, full transmit power automatically resumes.

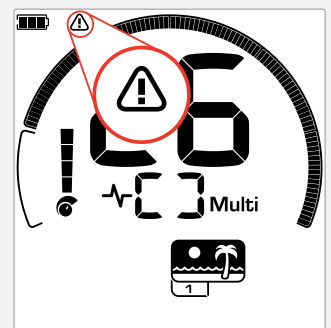

The Beach Overload Indicator appears when the transmit signal strength is automatically reduced.

Gold*



Best suited for gold nugget prospecting in mineralised goldfield locations.

Gold* Mode is for gold nugget prospecting. Generally, gold nuggets are found in remote goldfields where targets are more sparsely located.

Gold* Mode does not have the same Target Tone options as the other Search Modes. Instead, it has its own unique Prospecting Audio. This audio features a 'true' threshold tone (page 32) which provides more subtle variation in sound. When a target is detected, the signal volume and pitch vary proportionally to the strength of the target signal.

Gold* Mode is suited to finding smaller surface gold nuggets (and some larger deeper ones) in mineralised ground.

Gold Profile 1* – Normal Ground

Gold 1 is suitable for searching for small gold nuggets in 'mild' ground. Most goldfield locations have a variable level of iron mineralisation that will require an ongoing Ground Balance adjustment, therefore Tracking Ground Balance is the default setting. The audio Threshold Level and Threshold Pitch is optimised for hunting for gold nuggets.

Gold 1 Multi-IQ processes a high frequency weighted multi-frequency signal, while ground balancing for mineralised soil.

Gold Profile 2* – Difficult Ground

Gold 2 is best for searching for deeper gold nuggets in 'difficult' ground conditions. Gold 2 has a lower Recovery Speed, which will increase detection depth. However, more ground noise in more heavily mineralised grounds may result. Tracking Ground Balance is the default setting. The audio Threshold Level and Threshold Pitch is optimised for hunting for gold nuggets.

Gold 2 Multi-IQ processes a high frequency weighted multi-frequency signal, while ground balancing for mineralised soil.

* EQUINOX 900 only

Gold Detecting Hotspots

The best places to go detecting for gold nuggets are where gold has previously been found. Surrounding areas with very similar geology are also worth exploring. Many government mining agencies publish maps of goldfields locations and offer advice on obtaining relevant fossicking or hobby prospecting licences.

Go detecting in tailings from goldmine sites, old diggings from the 1800s, in and near streams where gold panning is carried out, arid dry-blowing locations and old reef mine dumps and slopes.

Difficult Gold Areas – Hot Rocks

'Hot' rocks are commonly found in gold prospecting locations. These are rocks that are mineralised differently to the surrounding ground. A highly mineralised rock buried in mildly mineralised ground would be considered to be a hot rock.

Hot rocks can easily be mistaken for gold nuggets. The Target ID can assist here, with hot rocks typically having a negative Target ID number and gold having a positive ID in the very low conductive range.

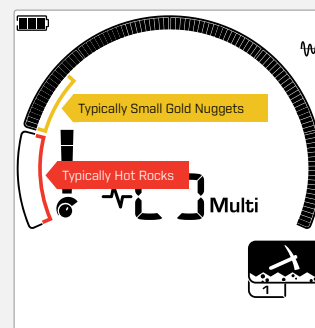

Target IDs 1 and 2 often indicate low conductive small gold nuggets. Hot rocks are generally found in the ferrous range.

General Settings

Global and Local Settings

Global Settings

All Search Mode Profiles will be affected by changes to the setting – all Search Modes and Search Profile icons are displayed.



Local Settings

Only the active Search Mode Search Profile will be affected by changes to the setting – Only the affected Search Mode and Profile are displayed.



Global and Local Settings Reference

General Settings

Sensitivity	Global
Backlight	Global
Flashlight	Global
Frequency	Local

Settings Menu

When you are adjusting items in the Setting Menu (Settings and Advanced Settings), the icons of affected Search Modes will appear on the LCD.

Noise Cancel	Local
Ground Balance	Local
Volume Adjust	Global
Master Vibration <i>incl. Tone Region Vibration</i>	Global
Tone Volume	Local
Tone Region Vibration <i>Unavailable if Master Vibration Off</i>	Local
Threshold Pitch*	Global
Target Tone	Local
Tone Pitch	Local
Accept/Reject	Local
Tone Break	Local
Recovery Speed	Local
Iron Bias	Local

* EQUINOX 900 only

Frequency

EQUINOX Series detectors have simultaneous multi-frequency capability with a technology called Multi-IQ, as well as a selection of single frequencies.

Frequency adjustment is local; only the current Search Mode Profile is affected by changes to this setting.

i For all Search Modes, Multi-IQ is the recommended Frequency setting.

! Perform a Noise Cancel (page 25) each time the Frequency is changed.

CHANGING THE FREQUENCY

1. Press the Frequency button to scroll through the available frequencies.

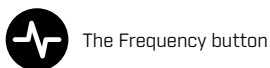

The Frequency is shown on the Frequency Display.

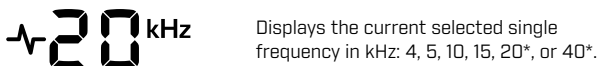

2. Perform a Noise Cancel (page 25).

MULTI-IQ OPERATION

Multi-IQ operates across the full spectrum of frequencies simultaneously, allowing it to cover a much broader range of targets than any one single frequency can.

Detecting using Multi-IQ is recommended wherever possible, as it will give you the best chance of detecting a broad range of targets whilst also giving a more stable and accurate target ID than single frequencies. See "Target ID Accuracy" on page 42 for more information.

SINGLE FREQUENCY OPERATION

Using a single frequency may have a slight advantage over multi-frequency in certain detecting situations.

For example; if you were searching only for larger high conductive targets located at great depth, using 4 or 5 kHz may give an advantage. Similarly, if you were hunting only for very fine gold jewellery at a shallow depth, then 20 kHz* or 40 kHz* (using Park, Field or Gold* modes only) may give better results in some detecting environments, such as at a beach on the dry sand.

In some noisy environments (e.g. high Electromagnetic Interference, where Noise Cancel is not fully effective), a single frequency may pick up less noise than Multi-IQ will, however maximum target sensitivity over a wide range of targets will be reduced.

FREQUENCIES AND SEARCH MODES

Not all frequencies are available in every Search Mode. Each Search Mode is limited to the frequencies that provide the best performance for that mode. For example, Park and Field Modes can operate across every available frequency setting, as good results can be achieved in any frequency.

Beach Mode however, can only perform successfully in typical beach conditions in Multi, therefore single frequencies are not available.

Similarly, Gold* Mode is optimised for detecting low conductive gold nuggets that are more easily detected at higher frequencies. Therefore the lower single frequencies (4, 5, 10, and 15 kHz) are not available.

EQUINOX 700

	Frequency (kHz)				
	Multi	4	5	10	15
Park	✓	✓	✓	✓	✓
Field	✓	✓	✓	✓	✓
Beach	✓	✗	✗	✗	✗

EQUINOX 900

	Frequency (kHz)						
	Multi	4	5	10	15	20	40
Park	✓	✓	✓	✓	✓	✓	✓
Field	✓	✓	✓	✓	✓	✓	✓
Beach	✓	✗	✗	✗	✗	✗	✗
Gold*	✓	✗	✗	✗	✗	✓	✓

* EQUINOX 900 only

Sensitivity



The EQUINOX Series detectors are highly sensitive and have adjustable Sensitivity. Setting the correct Sensitivity level for individual detecting conditions will maximise detection depth.

Always choose the highest stable Sensitivity setting to get the best performance from your detector.

The Sensitivity Indicator on the LCD shows the approximate Sensitivity level in increments of 5.

Sensitivity ranges from 1 to 25 for the EQUINOX 700, and 1 to 28 for the EQUINOX 900.

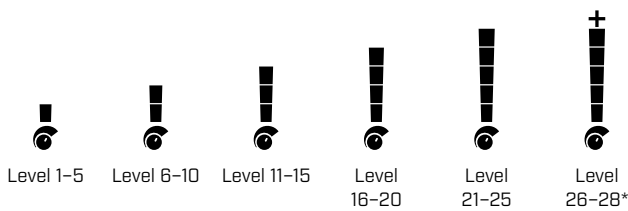

ADJUST THE SENSITIVITY LEVEL



Before reducing the Sensitivity, always try to resolve noise by first performing:

- Noise Cancel ([page 25](#)), followed by
- Ground Balance ([page 27](#))

The Sensitivity Level is shown on the Target ID Display while it is being adjusted, and will disappear after 3 seconds of inactivity.

1. Holding the coil stationary, use the Plus button to increase the Sensitivity level until false signals begin to occur.



The Plus button

2. Reduce the Sensitivity level by pressing the Minus button, just enough that the false signals disappear.



The Minus button

3. Sweep the coil over a clear patch of ground, and decrease the Sensitivity Level further if there is still some ground noise.

* EQUINOX 900 only

Depth Gauge



The Depth Gauge indicates the approximate depth of a detected target.

The Depth Gauge is a guide only. Fewer arrows indicate a shallower target, more arrows indicate a deeper target. The accuracy can vary depending on the target type and ground conditions.

After a target is detected, the Depth Gauge will remain on the LCD for 5 seconds, or until the next target is detected.

When there is no detection, the Depth Gauge icon and arrows are turned Off.

Here is an example of the Depth Gauge reading and the approximate target depth for a US quarter.

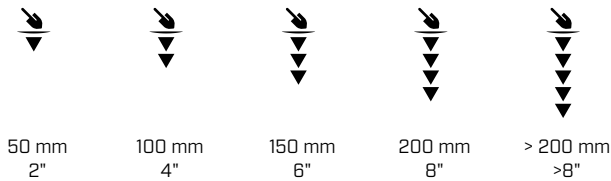

The Depth Gauge accuracy is reduced in highly mineralised soil.

Lighting

BACKLIGHT

EQUINOX 700 and 900 LCD and keypad have a backlight for detecting in low-light situations.

The Backlight will be Off by default each time the detector is powered On.

- EQUINOX 700 has 3 backlight level settings, Off, High, and Low.
- EQUINOX 900 has 4 backlight level settings, Off, High, Medium, and Low.

 Continual use of the backlight, especially at full brightness will result in decreased battery runtime.

Adjusting the Backlight

Press the Backlight button to cycle through the Backlight settings (from highest to lowest). The Backlight Indicator appears on the LCD when the Backlight is On.



The Backlight button



The Backlight indicator

FLASHLIGHT

EQUINOX 700 and 900 have a flashlight for detecting in low-light situations.

The Flashlight will be Off by default each time the detector is powered On.

 Continual use of the Flashlight will result in decreased battery runtime.

Turning the Flashlight On/Off

Long-press (2 seconds) the Backlight button.

The Flashlight indicator appears on the LCD when the Flashlight is On.



The Backlight button



The Flashlight indicator

Vibration

EQUINOX 700 and 900 have a Vibration feature that provides tactile feedback through the detector handle.

Vibration varies in intensity proportional to the target signal strength (for both detecting and Pinpoint).

Vibration is assigned to individual Tone Regions via the Tone Volume setting, allowing you to decide which types of targets give a vibration response.

- For EQUINOX 700, Vibration can only be turned On/Off for the Ferrous Tone Region (t1).
- For EQUINOX 900, Vibration can be turned On/Off for every Tone Region.

By default, Master Vibration is Off.

The Vibration setting will be remembered after the detector is powered Off. If Vibration is On, there will be a brief vibration pulse at start-up, and the Vibration icon will be displayed on the LCD.

i For EQUINOX 900 users, try turning Vibration On for Tone Region 1 (t1) only, and set t1 Volume to 0 (Off). This allows you to 'feel' ferrous detections instead of hearing frequent/repetitive signals when detecting in high-trash locations.

TURNING MASTER VIBRATION ON/OFF

1. Navigate to the Volume Adjust setting.



2. Press the Frequency button to toggle Master Vibration On/Off.



TURNING TONE REGION VIBRATION ON/OFF

When Master Vibration is On, Tone Region Vibration becomes available to adjust.

When Master Vibration is first enabled, Tone Region Vibration is turned Off for t1, and On for all other Tone Regions by default.

1. Press the Settings button to navigate to the Volume Adjust setting.



2. Long-press (2 seconds) the Settings button to select the Tone Volume Advanced Setting.



3. Press the Accept/Reject button to navigate to the Tone Region you wish to turn Vibration On/Off for (EQUINOX 900 only).



4. Press the Frequency button. There will be one brief vibration pulse. If turning Vibration On, the Vibration icon will appear on the LCD.



Note: The Vibration icon is displayed on the Detect Screen when Vibration is turned On, even if Vibration is turned Off for all Tone Regions.

User Profile*

EQUINOX 900 has a User Profile button on the side of the Control Pod that saves a copy of the current detector settings for future quick access.

The User Profile provides you with a quick and easy way to toggle between two sets of detecting settings – those saved to the User Profile, and the last-used detector settings.

The default settings for the User Profile are a copy of Park Mode 1.

 The User icon appears on the LCD when the User Profile is turned On.

Any changes made to local settings when the User Profile is active will be saved automatically.

SAVE A USER PROFILE

1. Adjust the detector to the settings you want to save.
2. Make sure you are in the Detect Screen, not the Settings Menu.
3. Press-and-hold the User Profile button until the User Profile icon begins to flash.



4. Release the button after the confirmation tone. The User Profile icon will remain On.

Save over the User Profile at any time by repeating the steps.

TURN THE USER PROFILE ON/OFF

Turn On

To turn the User Profile On, press the User Profile button.



Turn Off

To turn Off the User Profile, press either the User Profile button or the Search Mode button. Settings will return to the last-used Search Mode Profile.

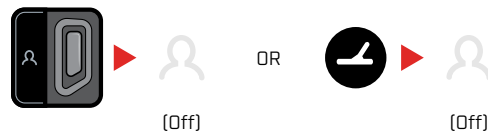

* EQUINOX 900 only

Settings Menu

Settings Menu Navigation

The Settings Menu contains adjustable settings relating to the detector. You can change audio and other detecting settings via this menu.

SETTINGS MENU NAVIGATION



The Settings Menu can be accessed from any screen by pressing the Settings button.

Each press of the Settings button will scroll to the next setting in the Settings Menu in a left-to-right direction. After the last Setting the detector returns to the Detect Screen. Press the Settings button again to begin scrolling from the left again.

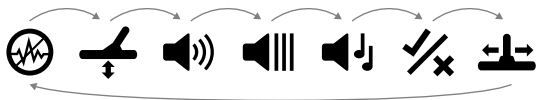

Press either the Search Mode button or the Pinpoint/Detect button from the Settings Menu to return to the Detect Screen.

The Settings Menu remembers the last accessed setting and will return to that setting the next time the Settings button is pressed.

ACCESSING ADVANCED SETTINGS

1. Press the Settings button to navigate to any top level Setting that has an Advanced Setting.
2. Long-press (2 seconds) the Settings button to select the Advanced Setting, indicated by a line beneath the icon.



3. To return to the top-level setting, Long-press (2 seconds) the Settings button.

The Settings Menu remembers if an Advanced Setting was last accessed and will return you to that setting next time the Settings button is pressed.

Noise Cancel



Detectors can become noisy due to electrical interference from power lines, electrical equipment or other detectors operating nearby. The detector interprets this interference as inconsistent, erratic detections.

The Noise Cancel setting allows you to change the noise cancel channel. This slightly shifts the detector transmit frequency to be less responsive to the source of the noise.

Noise Cancel affects both the audible detection noise level and pinpointing performance.

Noise Cancel adjustment is local; only the current Search Mode Search Profile is affected by changes to this setting.

The Noise Cancel setting has 19 channels with a range from -9 to 9. It has a default setting of 0 [zero] for all Search Modes.

! Perform a Noise Cancel (page 25) each time the Frequency is changed.

i Auto is the recommended Noise Cancel method.

AUTO NOISE CANCEL

Auto Noise Cancel automatically scans and listens to every frequency channel and then selects the one with the least interference.

1. Hold the coil stationary and away from the ground.

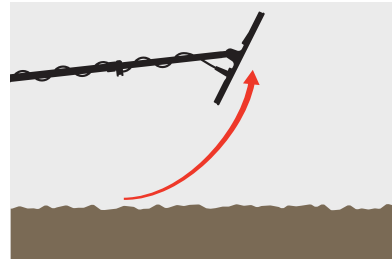

2. Press the Settings button to navigate to the Noise Cancel setting.



3. Press the Accept/Reject button to initiate the Auto Noise Cancel process. Auto Noise Cancel can also be initiated on the EQUINOX 700 by pressing the Minus [-] or Plus [+] buttons.



4. The Auto Noise Cancel progress is indicated on the Discrimination Scale, and by a series of ascending tones.

When this process is complete (after approximately 5 seconds), the automatically selected channel appears on the Target ID Display, and there are three confirmation tones.

i Note: While Auto Noise Cancel selects the 'quietest' channel based on several criteria, the selected channel may still have some audible noise.

To try and reduce noise further, consider adjusting Sensitivity.

* EQUINOX 900 only

Noise Cancel *(Continued)*

MANUAL NOISE CANCEL*

Setting the Noise Cancel manually allows you to listen to each channel to select the one with the least interference. This can be useful when detecting in close proximity to other detectors or in locations with lots of electrical interference.

1. Hold the coil stationary and away from the ground.

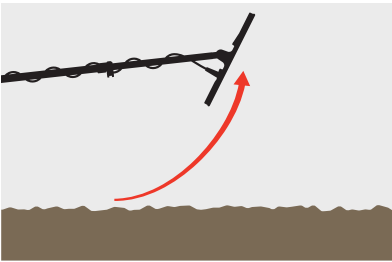

2. Press the Settings button to navigate to the Noise Cancel setting.



3. Press the Minus [-] or Plus [+] buttons to adjust the channel.



The channel is shown on the Target ID Display. Pause and listen to the interference levels – keep the detector still during this process.

4. Continue until you have chosen the channel with the least interference.

CONTINUOUS AUTO NOISE CANCEL

Pressing and holding the Accept/Reject button or the Minus [-] or Plus [+] buttons in the Noise Cancel setting will initiate a Continuous Auto Noise Cancel, where the detector will continue to run multiple noise cancel cycles for a longer period until the button is released. After each noise cancel cycle, the best noise cancel channel measured over all cycles will be displayed.

Using Continuous Auto Noise Cancel to run Noise Cancel over a longer period can help select the quietest channel at sites where there are EMI sources that are variable over time.

Ground Balance



The Ground Balance setting calibrates the detector to the local ground in order to eliminate the false signals caused by mineralisation.

The Ground Balance setting has a range from -9 to 99, with a default of 0 [zero] for all Park, Field, and Beach Mode Search Profiles.

Tracking Ground Balance is the recommended and default ground balance method for Gold* Mode.

Ground Balance adjustment is local; only the current Search Mode Search Profile is affected by changes to this setting.

i The default Ground Balance setting of 0 [zero] is recommended for Park, Field and Beach Modes because these locations typically have less mineralisation than goldfields.

However, if the ground is generating many noise signals (and/or the Sensitivity level is set very low), then using Auto Ground Balance is recommended.

If the Auto Ground Balance process does not greatly reduce ground noise (due to highly mineralised ground or high salt levels), then repeat the Auto Ground Balance process by sweeping the coil from side-to-side, rather than the standard up-and-down motion.

AUTO GROUND BALANCE

Auto Ground Balance automatically determines the best Ground Balance setting, however the process must be initiated by the user.

Using Auto Ground Balance is the recommended Ground Balance Method.

1. Press the Settings button to navigate to the Ground Balance setting.



2. **Press-and-hold** the Accept/Reject button throughout the Auto Ground Balance process.

The Tracking Ground Balance icon on the LCD will begin to flash rapidly.



3. Raise and lower the coil repeatedly over a clear patch of soil that does not contain any targets. Observe the Ground Balance number updating dynamically on the Target ID Display, as the audio reduces in response to the ground.

The response will be stabilised when the value in the Target ID Display settles on a number, and the audible response is minimised.

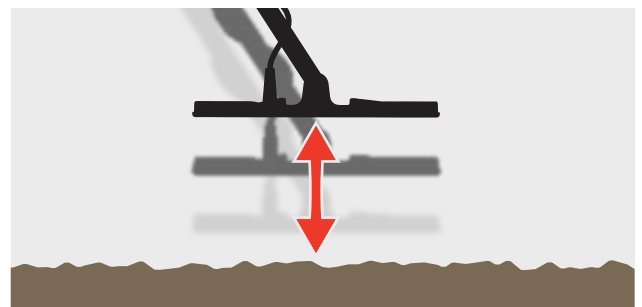

4. Release the Accept/Reject button.

* EQUINOX 900 only

Ground Balance *(Continued)*

MANUAL GROUND BALANCE

Ground Balance can be manually adjusted until the minimum amount of ground signal is present.

1. Press the Settings button to navigate to the Ground Balance setting.



2. Raise and lower the coil repeatedly over a clear patch of soil that does not contain any targets.

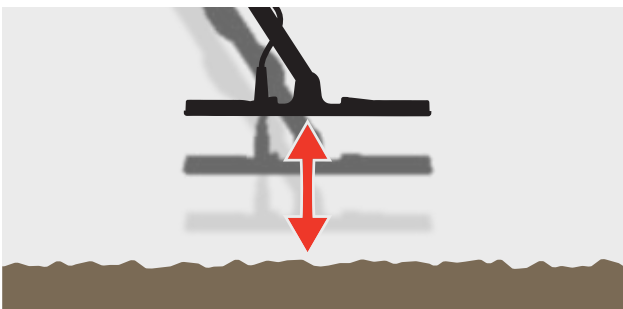

Listen to the audio response to interpret the result of the Ground Balance; a low tone indicates that you should increase the Ground Balance value and a high tone indicates that you should decrease it.

3. Press the Minus [-] and Plus [+] buttons to manually change the Ground Balance value until the minimum amount of ground signal is heard. The Manual Ground Balance value is shown on the Target ID Display.



TRACKING GROUND BALANCE

When Tracking Ground Balance is active, the detector continuously adjusts the Ground Balance automatically during detecting. This ensures that Ground Balance is always set correctly.

i Tracking Ground Balance is the default and recommended method for Gold* Mode.

Tracking Ground Balance can also be useful when using Beach Mode 2 underwater at the beach (in salt water).

1. Press the Settings button to navigate to the Ground Balance setting.



2. Press the Accept/Reject button to toggle Tracking Ground Balance On/Off.



When Tracking Ground Balance is On, the Tracking Indicator will appear on the LCD, and Ground Balance will track automatically in the background.

* EQUINOX 900 only

Volume Adjust



Volume Adjust changes the loudness of all detector audio, including detection signals, the threshold tone, and confirmation tones.

Volume Adjust changes are global.

The Volume Adjust setting has a range from 0 (Off/muted) to 25 with a default setting of 20.

ADJUST THE VOLUME

1. Press the Settings button to navigate to the Volume Adjust setting.



2. Use the Minus (-) or Plus (+) buttons to decrease or increase the volume to a comfortable level, making sure that loud signals (close or large targets) do not hurt your ears.



Tone Volume *(Advanced Setting)*



The Tone Volume setting allows you to set a different volume level for each Tone Region. This is a useful feature when detecting in iron infested locations.

Tone Volume adjustment is local; only the current Search Mode Search Profile is affected by changes to this setting.

The Tone Volume setting has a default setting of 25 for non-ferrous tones, and a reduced volume for ferrous tones depending on the selected Search Mode.

i Tone Volume is not available for Gold* Mode, or when Target Tone is set to 1 Tone.

The number of Tone Regions is defined by the Target Tone setting, up to a maximum of 5 Tone Regions. Read "[Change the Number of Target Tones](#)" on page 34 for more information.

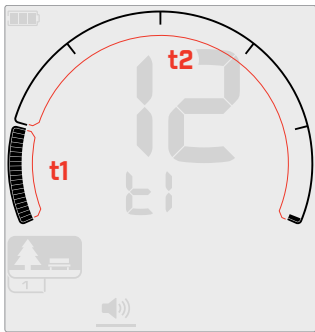

Tone Volume adjustment screen for Tone Region 1 (t1) when Target Tone is set to 2. The Discrimination Scale is divided into 2 regions.

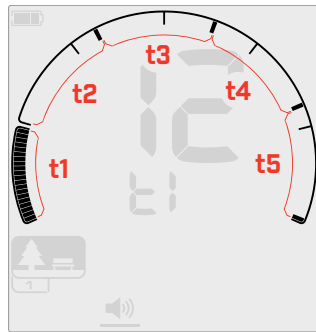

Tone Volume adjustment screen for Tone Region 1 (t1) when Target Tone is set to 5. The Discrimination Scale is divided into 5 regions.

ADJUST TONE VOLUME

i Before adjusting Tone Volume, select your preferred Target Tones setting ([page 34](#)).

This is because changes to Tone Volume only apply to the active Target Tone setting.

i **Note:** only the ferrous tone (t1) can be adjusted on the EQUINOX 700.

1. Press the Settings button to navigate to the Volume Adjust setting.



2. Long-press [2 seconds] the Settings button to select the Tone Volume Advanced Setting.



3. The Frequency Display will indicate the Tone Region that is currently selected (e.g. t1) and the Tone Region segments on the Discrimination Scale will be On.

Press the Minus [-] or Plus [+] buttons to adjust the volume of the selected Tone Region.



4. Press the Accept/Reject button again to advance to the next Tone Region.

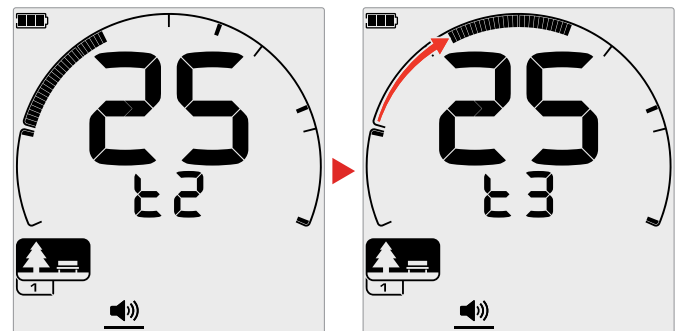

5. Repeat until all Tone Regions have been adjusted.

i In trashy or iron infested locations, set the Tone Volume of the ferrous Tone Region to be just-audible, and then increase the volume of the Tone Regions where your preferred targets will appear, in order to emphasise them.

This way, you can hear how much ferrous trash is being detected. If you hear lots of ferrous trash, detect more slowly so you don't miss desired targets. If you hear very little ferrous trash, you can detect more quickly.

* EQUINOX 900 only

Threshold Level



A Threshold tone is the constant background sound that is a useful for hearing faint target responses.

Threshold Level changes are global, with a separate setting for Gold* Mode.

The Threshold Level setting has a range from 0 to 25.

The default Park/Field/Beach Modes Threshold Level is 0 (Off). The default Gold* Mode Threshold Level is 12.

ADJUST THE THRESHOLD LEVEL

1. Press the Settings button to navigate to the Threshold Level setting.



2. Use the Minus [-] or Plus [+] buttons to adjust the Threshold Level. Adjustment takes effect immediately, so listen to the audio to select your preferred level.



With the EQUINOX 900, the pitch of the threshold tone can be set higher or lower via the Threshold Pitch Advanced Setting (page 33).

'REFERENCE' THRESHOLD TONE

The Park, Field and Beach Modes use a simplified 'reference' threshold tone. Unlike the 'true' threshold tone that is used by the Gold* Mode, the 'reference' threshold is a simple continuous background tone that blanks when a rejected Target ID is detected.

Without a reference threshold, a rejected target detection would be silent, and you would not be made aware of the target's existence.

For typical treasure detecting locations where there is often a large amount of trash in the ground, constant audio blanking may be disruptive, therefore using a Threshold Level setting of 0 (Off) is recommended unless you want to hear audio blanking.

Reference Threshold Blanking

When a Rejected ID is detected, the threshold tone 'blanks' (becomes silent) to indicate that a rejected target is underneath the coil.

If the Threshold Level is set to 0 (Off), you will not hear the blanking of the Rejected ID's.

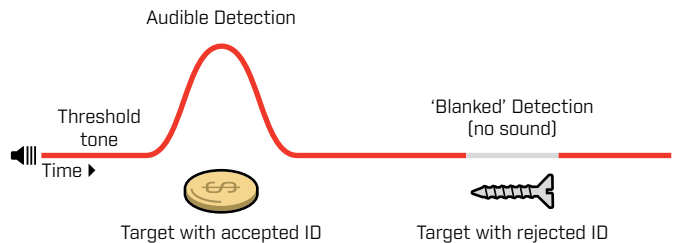

* EQUINOX 900 only

Threshold Level *(Continued)*

'TRUE' THRESHOLD TONE

When in Gold* Mode a 'true' threshold tone is used and is ideal for gold detecting, especially for small nuggets.

Unlike the simplified 'reference' threshold tone that is used by the Park, Field and Beach Modes, the 'true' threshold is a continuous background tone that can be adjusted to improve the audibility of faint signals and gives more target information through changes in volume depending on target signal strength and composition.

'True' threshold allows faint gold signals to be emphasised in noisy soils. Greater control of the target audio response may be achieved by adjusting the Threshold Level and Volume Adjust settings together.

Too Low

If the Threshold Level is too low, the slight variation caused by a small or deep target may not be sufficient to hear. Adjusting the level to below an audible level will ensure silent operation but could mask the audio response from small or deep targets.

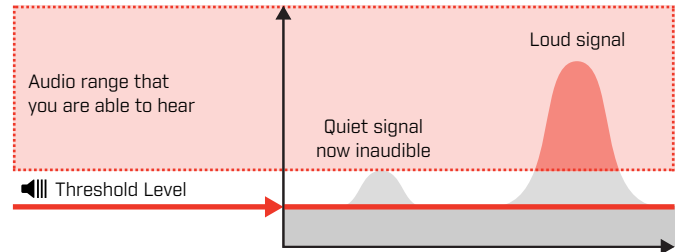

Too High

If the Threshold Level is too high, faint targets will be harder to hear above the Threshold hum.

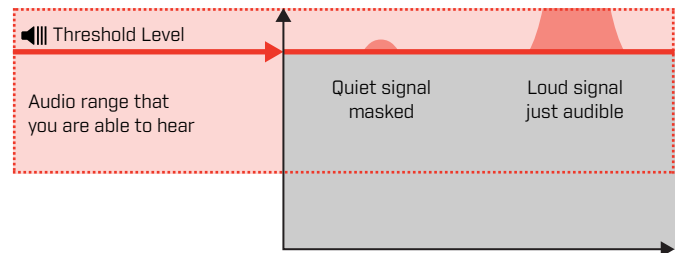

Just Right

Adjust the Threshold Level to a faint audible hum. This will emphasise variations in signal response which may indicate the presence of a target. If the soil conditions change, the Threshold Level may need further adjustment.

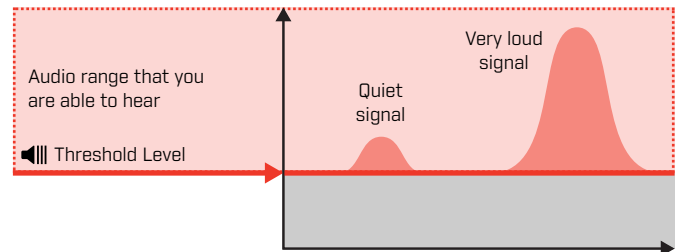

* EQUINOX 900 only

Threshold Pitch* (Advanced Setting)



This EQUINOX 900 Advanced Setting allows you to set the threshold tone to be higher or lower pitched. Set the level to the most comfortable pitch for your hearing.

Threshold Pitch changes are global, with a separate setting for Gold* Mode.

The Threshold Pitch setting has a range from 1 to 25.

The default Park/Field/Beach Modes Threshold Pitch is 4.

The default Gold* Mode Threshold Pitch is 11.

ADJUST THE THRESHOLD PITCH

1. Press the Settings button to navigate to the Threshold Level setting.



2. Long-press (2 seconds) the Settings button to select the Threshold Pitch Advanced Setting. 'Pt' will appear on the Frequency Display.



3. Press Plus (+) to set the threshold tone to a higher pitch. Press Minus (-) to set the threshold tone to a lower pitch. Any adjustments are automatically saved.

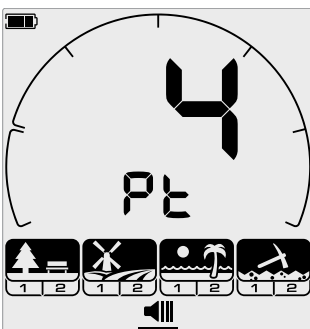

The Threshold Pitch adjustment screen.

* EQUINOX 900 only

Target Tone



The Target Tone Setting controls the number of different tones you will hear for different types of targets, and the number of adjustable

Tone Regions for Advanced Settings.

Target Tone allows you to divide the Target ID range into separate Tone Regions. Therefore, you can hear more or less target information.

For The Target Tone setting has the options of 1, 2, 5, All Tones (At) and Depth (dP).



Gold* Mode has a Target Tone setting of 1 only, and cannot be changed.

Target Tone adjustment is local; only the current Search Mode Search Profile is affected by changes to this setting.

CHOOSING A TARGET TONE SETTING

1 Tone

Target responses give long and short beeps of the same pitch, regardless of their Target ID.

2 and 5 Tones

Target responses give long and short beeps in 2 or 5 different pitches depending on their Target ID.

All Tones (At)

Target Responses give long and short beeps with a different pitch for every Target ID.

Depth (dP)

Target Responses vary in pitch and volume proportional to the target signal strength. All targets increase in volume proportional to the target signal strength, therefore large or shallow targets will sound louder than small or deep targets.

Conductive targets increase in pitch, and ferrous targets have a constant low-pitch.

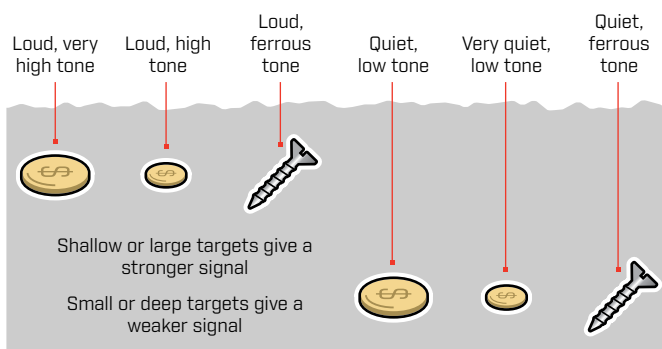

* EQUINOX 900 only

CHANGE THE NUMBER OF TARGET TONES

1. Press the Settings button to navigate to Target Tone.



2. Use the Minus (-) and Plus (+) buttons to select the new Target Tone setting.



The setting is indicated on the Target ID Number.



Target Tone Dependencies

When the Target Tone setting is changed, the options for the following Advanced Settings also change:

- Tone Volume
- Tone Pitch
- Tone Break

For this reason, choose your Target Tone setting before you begin adjusting the Tone Volume, Tone Pitch, and Tone Break settings.

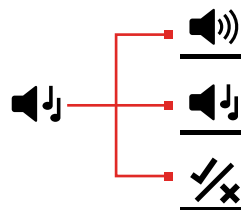

Tone Pitch *(Advanced Setting)*



This Advanced Setting allows you to adjust the pitch of target responses for specific types of targets. This makes it easier to hear your preferred targets.

The pitch of each Tone Region can be adjusted. This may be useful to help differentiate between common targets with similar Target IDs.

The Tone Pitch setting has a range from 1 to 25.

Tone Pitch adjustment is local; only the current Search Mode Profile is affected by changes to this Advanced Setting.

EQUINOX 700 allows only the first Tone Pitch to be adjusted. EQUINOX 900 allows all Tone Pitches to be adjusted.



Tone Pitch is not available for Gold* Mode, or when the selected Search Mode is using the Depth [dP] Target Tone setting.



Before adjusting Tone Pitch, select your preferred Target Tones setting [\[page 34\]](#).

This is because changes to Tone Pitch only apply to the active Target Tone setting.

ADJUST TONE PITCH – 1, 2, OR 5 TONES

1. Press the Settings button to navigate to the Target Tone setting.



2. Long-press (2 seconds) the Settings button to select the Tone Pitch Advanced Setting.



3. The Frequency Display will indicate the Tone Region that is currently selected (e.g. t1) and the Tone Region segments on the Discrimination Scale will be On. Press the Minus (-) or Plus (+) buttons to adjust the volume of the selected Tone Region.

Press Plus (+) to set the Target Tone to a higher pitch. Press Minus (-) to set the Target Tone to a lower pitch.



4. To advance to adjusting the pitch of the next Tone Region (i.e. t2), press the Accept/Reject button.

Note: if the Target Tone setting is set to 1, there will only be 1 Tone Region (t1).

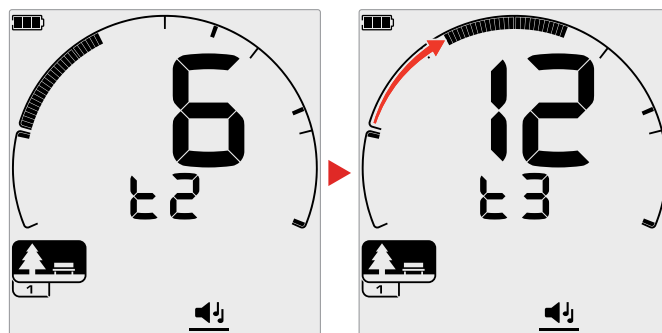

* EQUINOX 900 only

Tone Pitch (Advanced Setting) (Continued)

ADJUST TONE PITCH – ALL TONES

When All Tones (At) is the selected Target Tone setting, the Tone Pitch Advanced Setting behaves similarly to the 2-Tone Setting – however instead of all targets in each region playing at the set pitch, this value sets the pitch for the first ID in that region. Pitches then increase across the range for the other ID's.

- The pitch of the ferrous region has a range of 50 Hz.
- The pitch of the non-ferrous region has a range of 500 Hz.

You can configure the starting points to create a continuous range of pitches from ferrous to non-ferrous targets, or you can create a Pitch Gap, in order to better differentiate between ferrous and non-ferrous targets.

The examples show how adding a pitch gap makes it easier to hear a clear difference between ferrous and non-ferrous targets.

Default Tone Pitch Gap [1, 20]

Ferrous targets will be very low-pitched. Non-ferrous targets will sound distinctly higher-pitched than a ferrous target with a similar Target ID.

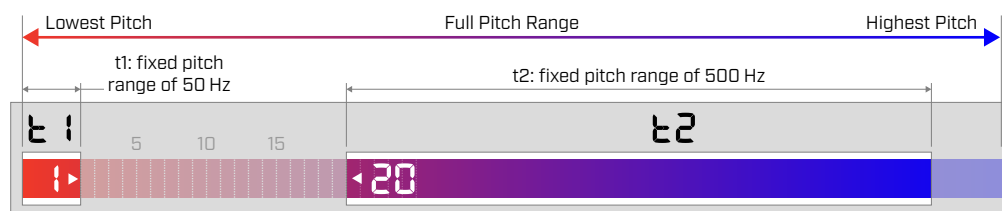

Maximum Tone Pitch Gap [1, 25]

A greater difference in Pitch between ferrous and non-ferrous targets gives very easy differentiation.

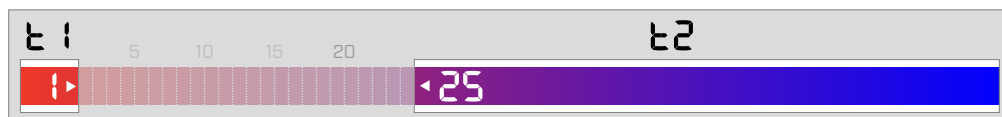

Small Tone Pitch Gap [11, 12]

No clear difference in pitch between ferrous and non-ferrous targets. They may be indistinguishable from audio alone.

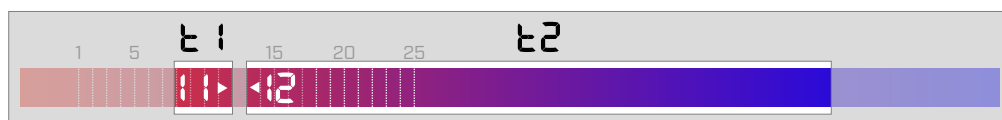

Accept/Reject



You can create your own discrimination patterns to detect or ignore specific target types, so you can dig more treasure and less trash.

Targets are represented by both a Target ID number and an individual segment on the Discrimination Scale (page 58). Target ID segments can be turned On/Off to either detect (accept) or ignore (reject) targets. All Target IDs that are On will be accepted and all Target IDs that are Off will be rejected.

The combinations of accepted and rejected segments are referred to as discrimination patterns.

The Discrimination Scale has a range from -19 to 99.

Discrimination patterns are local, only the current Search Mode Profile discrimination pattern will be changed.

CREATING A DISCRIMINATION PATTERN

1. Press the Settings button to navigate to the Accept/Reject setting.



2. Use the Minus [-] and Plus [+] buttons to navigate to the Target ID you wish to change. Each press moves one segment in a clockwise/anticlockwise direction.



3. The current selected Discrimination Segment will flash slowly, and the exact Target ID number will be displayed.

Press the Accept/Reject button to toggle the Target ID On/Off.



You can also rapidly turn a series of segments On/Off by pressing and holding the Accept/Reject button. For example, if segment 5 is selected and turned Off, press-and-hold the Accept/Reject button to turn that segment On, then continue to hold the button. The selector will automatically move to the next segment and turn it On, and so-on. To stop, release the button.

5. Continue to navigate around the Discrimination Scale, turning Target IDs On/Off with the Accept/Reject button until you have created your discrimination pattern.

ACCEPT OR REJECT TARGETS UPON DETECTION

A target can be rejected upon detection if the corresponding Target ID is currently Accepted in the discrimination pattern.

If a Target ID is currently accepted and a detection occurs, an audio response will be heard, the Target ID segment will flash, and the Target ID number will be displayed.

To reject a detected target, press the Accept/Reject button.



Targets with that Target ID will now be rejected, and will not be heard.

The last rejected target can be instantly re-accepted by pressing the Accept/Reject button again, as long as no other detection occurs before doing so.

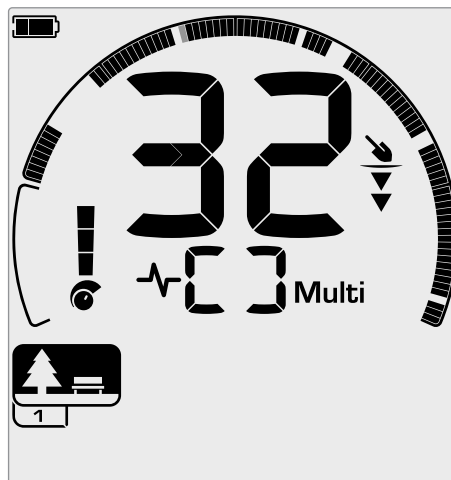

Example showing the detection of an accepted non-ferrous target with a Target ID of 32. Segment 32 on the Discrimination Scale will flash.

Accepting a rejected Target ID is not possible directly from the Detect Screen. Rejected Target IDs must be re-accepted by adjusting the discrimination pattern via the Accept/Reject Setting in the Settings Menu.

ALL METAL

All Metal is turned Off by default each time the detector is powered On.



Turn All Metal On/Off by pressing the All Metal button.

When All Metal is On, the current discrimination pattern is disabled so that all metal objects will be detected.

Tone Break *(Advanced Setting)*



This Advanced Setting allows you to move the end position of each Tone Region.

A common use of the Tone Break setting is to manually control the point at which ferrous tones occur. A use-case example of this is coke; coke is an undesirable non-ferrous 'pest' target that typically has a Target ID of 1.

By moving the ferrous tone end position up to 2, coke is moved into ferrous range and will now give a ferrous response. Note however that some low conductive targets will now give the same response as a 'bad' ferrous target.

You can also adjust the end positions of other Tone Regions to gain greater distinction between targets of varying conductivity levels.

Target IDs -19 to 0 are set as ferrous by default for Park and Beach Modes, and -19 to 4 for are set as ferrous by default for Field Mode.

Tone Break adjustment is local; only the current Search Mode Profile is affected by changes to this Advanced Setting.

i Tone Break is not available for Gold* Mode, or when Target Tone is set to 1 Tone.

ADJUST TONE BREAK

i Before adjusting Tone Break, select your preferred Target Tones setting [\(page 34\)](#).

This is because changes to Tone Break only apply to the active Target Tone setting.

EQUINOX 700 allows only the ferrous Tone Break position (t1) to be adjusted. EQUINOX 900 allows 4 Tone Break positions (t1, t2, t3, t4) to be adjusted.

1. Press the Settings button to navigate to the Accept/Reject setting.



2. Long-press (2 seconds) the Settings button to select the Tone Break Advanced Setting.



3. The Tone Region currently selected will be displayed on the Frequency Display (e.g. t1). The Target ID Display will show the current value of the Tone Region end point, (e.g. 0), and the corresponding Target ID segment will flash slowly.
4. Use the Minus [-] and Plus [+] buttons to navigate to the Target ID you wish to use as the end position. Each press moves one segment in a clockwise/anticlockwise direction.



5. To advance to adjusting the next Tone Region end position (i.e. t2), press the Accept/Reject button.



Note: The last Tone Region end position cannot be adjusted because the end position is always 99.

* EQUINOX 900 only

Recovery Speed

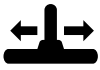

The Recovery Speed setting alters how quickly the detector responds from detecting one target to detecting another target.

By increasing the Recovery Speed, the detector is able to better differentiate between multiple targets that are close together. This assists in high-trash areas with finding smaller good targets amongst larger iron trash.

EQUINOX 700 Recovery Speed ranges from 0 to 4.
EQUINOX 900 Recovery Speed ranges from 0 to 8.

Recovery Speed adjustment is local; only the current Search Mode Profile is affected by changes to this setting.

While using a higher target Recovery Speed may increase the ability of the detector to find difficult targets, it also results in reduced Target ID accuracy and less detection depth.

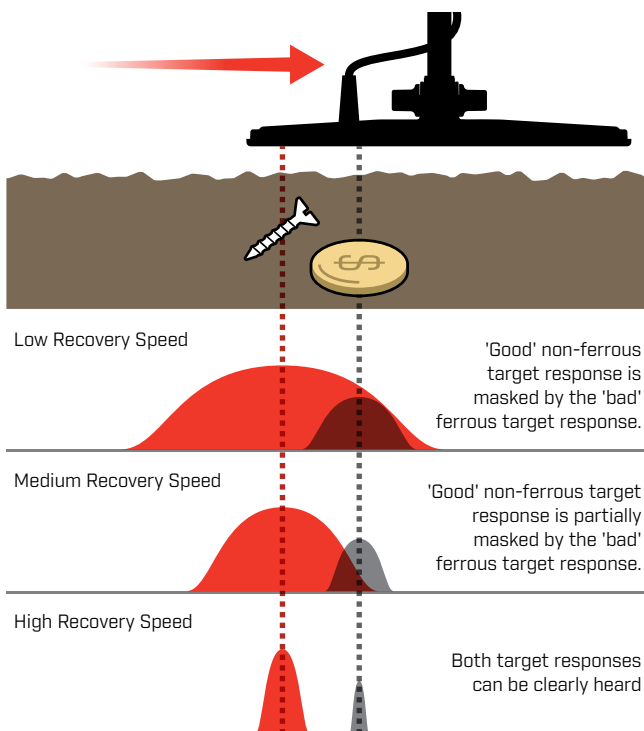

ADJUST RECOVERY SPEED

When adjusting the Recovery Speed for the first time, lay out some overlapping targets to test how the detector responds with different Recovery Speed settings.

1. Press the Settings button to navigate to the Recovery Speed setting.



2. Use the Minus [-] and Plus [+] buttons to decrease or increase the Recovery Speed. Adjustments are automatically saved.



EQUINOX 700/900 Equivalent Recovery Speeds

The following shows the equivalent recovery speeds between the two models. EQUINOX 700 has fewer adjustment increments and a slower maximum Recovery Speed than the EQUINOX 900.

EQUINOX 900	1	2	3	4	5	6	7	8
EQUINOX 700		1		2		3		

SWING RATE

A good general swing rate is around 2 to 3 seconds from right-to-left-to-right. A higher Recovery Speed generally allows you to swing at a faster rate without missing many targets.

A higher Recovery Speed at the same swing rate will help to reject ground noise, however it will also decrease detection depth.

If you are experiencing high levels of ground noise at the beach, or when detecting underwater, try increasing the Recovery Speed to reduce the noise.

A lower Recovery Speed at the same swing rate will increase detection depth, however may increase noise.

Varying both Recovery Speed and swing rate can help minimise ground noise.

Iron Bias (Advanced Setting)

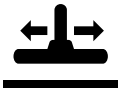

Iron Bias allows the detector to correctly classify large or complex ferrous targets (e.g. rusty nails or crown bottle caps) as ferrous so that they are more easily rejected.

Iron Bias is only available when the operating frequency is set to Multi.

Iron Bias adjustment is local; only the current Search Mode Profile is affected by changes to this setting.

EQUINOX 900 Iron Bias ranges from -1 to 9.

EQUINOX 700 Iron Bias ranges from -1 to 3.

Note: For EQUINOX 600 and 800 users, be aware that Iron Bias settings are not identically configured and named in the 700 and 900 models.

HOW IRON BIAS WORKS

All ferrous targets produce a combination of ferrous and non-ferrous responses. Large ferrous targets can present an even stronger non-ferrous response. Adjacent ferrous and non-ferrous targets can produce a similar response.

CHOOSING AN IRON BIAS SETTING

Set the Iron Bias Setting to suit the type of targets you want to detect or ignore.

Lower Iron Bias Settings

A lower Iron Bias setting [-1 to 4 on EQUINOX 900, or -1 to 2 on EQUINOX 700] is recommended in areas where you do not want to miss any non-ferrous targets amongst iron trash, however more ferrous targets will be detected and misidentified as desirable non-ferrous targets.

When using a lower Iron Bias setting, detecting in All Metal Mode is recommended to avoid missing any desirable targets.

Higher Iron Bias Settings

A higher Iron Bias setting [5-9 on EQUINOX 900, or 3 on EQUINOX 700] is recommended in environments with dense iron trash, or for rejecting crown bottle caps.

When using a higher Iron Bias setting, detecting using a ferrous-masking discrimination pattern is recommended to mask as many ferrous detections as possible.

ADJUST THE IRON BIAS

The Iron Bias Setting provides tone and Target ID response adjustment for a wide range of ferrous targets.

1. Press the Settings button to navigate to the Recovery Speed setting.



2. Long-press [2 seconds] the Settings button to select the Iron Bias Advanced Setting. 'FE' will appear on the Frequency Display.



3. Use the Minus [-] and Plus [+] buttons to adjust the Iron Bias setting. Adjustments are automatically saved.

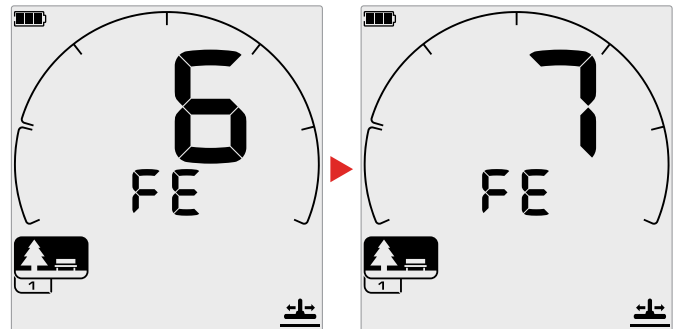

EQUINOX 700/900 Iron Bias Setting Equivalents

The following shows the equivalent Iron Bias settings between the two models. EQUINOX 700 has fewer adjustment increments than the EQUINOX 900.

EQUINOX 900	-1	0	1	2	3	4	5	6	7	8	9
EQUINOX 700	-1	0	1	2	3						

Target Identification, Pinpointing & Recovery

Target Identification

TARGET IDENTIFICATION NUMBER

Target Identification (Target ID) numbers range from -19 to 99 with ferrous (iron) targets ranging from -19 to 0.

When a target is detected, it is represented as a number that appears on the Target Identification Number field on the display. This indicates the target's ferrous or non-ferrous properties for quick and easy identification.

For example, a US quarter has a Target ID of 89. This means that each time a Target with an ID of 89 is detected, there is a good chance that it will be a US quarter.

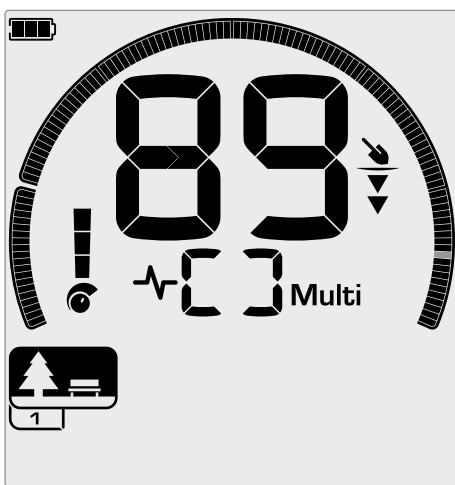

A Target ID number appears when a target is detected. This example shows the detection of a shallow US quarter. The corresponding Target ID Segment flashes upon detection (flashing segment shown in grey).

The last detected Target ID remains on the display for five seconds or until another target is detected.

Note: Some non-ferrous targets display a negative ID if there is an adjacent ferrous target.

Target ID Accuracy

Multi-IQ technology gives greater Target ID accuracy and increased detecting performance, especially in heavily mineralised ground. In benign ground, a single frequency may perform adequately, however depth and stable Target IDs will be limited by ground noise.

Multi-IQ simultaneous multi-frequency will achieve maximum depth with a very stable target signal. In mineralised ground, single frequencies will not be able to effectively separate the target signal from the ground signal, giving decreased results. Multi-IQ will still detect at depth, losing a minimal amount of Target ID accuracy.

If there is no detection or the detector passes over a target that it rejects, the display shows two large dashes.

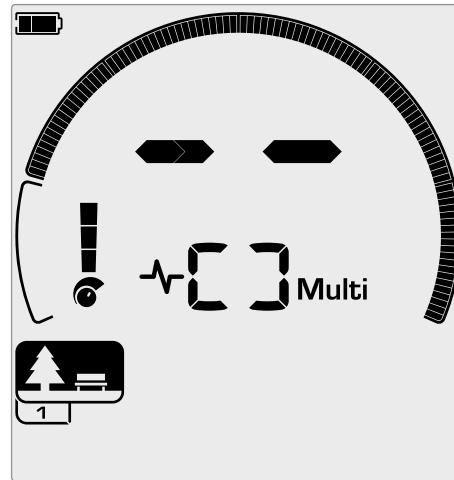

Two large dashes on the Target Identification Number field when there is no detection.

DISCRIMINATION SCALE

The circular Discrimination Scale corresponds to the 119 Target IDs. Accepted (detected) targets are shown as visible segments, and will flash when a target with that ID is detected. Rejected (non-detected or 'blanked') targets are turned Off.

Discrimination Segments are turned On (accepted) or Off (rejected) to create Discrimination Patterns.

You can discriminate between desired and undesired targets that appear along the Discrimination Scale. Therefore you only hear target signals from those you want to find, and unwanted targets are ignored.

You can do this by the following methods:

- Accepting/Rejecting detected targets upon detection using the Accept/Reject button. See "[Accept or Reject Targets Upon Detection](#)" on page 37.
- Creating a discrimination pattern via Accept/Reject in the Settings Menu. See "[Creating a Discrimination Pattern](#)" on page 37.

Pinpoint

Pinpointing helps you to quickly narrow down the location of a buried target, allowing you to determine its exact location before digging.

Pinpointing can be done in two different ways:

- Using the Pinpoint Function (see "Locate a Target Using Pinpoint Mode" on page 43)
- Using a manual pinpointing technique (see "Locate a Target Manually" on page 44)

The difference in tone and volume will help to identify the position and depth of the target.

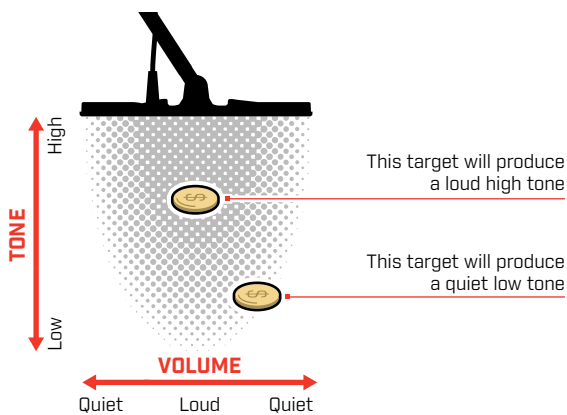

PINPOINT MODE VISUALISATION

When Pinpoint Mode is turned On, the discrimination pattern is temporarily disabled (i.e. All Metal is enabled). Pinpoint Mode also switches Off motion detection, so target signals occur even if the coil is stationary.

As the centreline of the coil approaches the target, discrimination segments will fill from the outside towards the centre. When the Discrimination Segments are all On, the target is directly beneath the centreline of the coil.

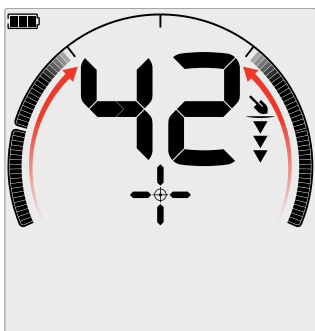

Weak/off-centre target signal: Fewer discrimination segments are On. The target is located nearer to the outside of the coil.

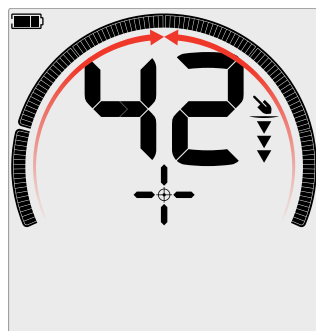

Strongest target signal: All discrimination segments are On. The target is located directly below the centreline of the coil.

LOCATE A TARGET USING PINPOINT MODE

1. Hold the coil away from the approximate target location, then press the Pinpoint button once to turn Pinpoint Mode On. The Pinpoint Indicator cross-hairs will appear on the display.

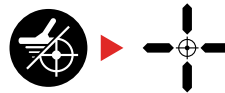

2. Keeping the coil parallel to the ground, sweep slowly over the target location two or three times. This calibrates the Pinpoint function for more accurate pinpoint audio responses.
3. Locate the centre of the target by listening for the loudest signal and/or watching the Pinpoint Visualisation on the display.

Note: The Target ID will continue to update whilst in Pinpoint Mode, allowing you to confirm that you are pinpointing the correct target and not an adjacent trash object.

Note: the Pinpoint function progressively masks the target response by reducing the Sensitivity with each sweep until only a very narrow target response remains.

4. When all of the segments on the Discrimination Scale are On, the target will be below the centre of the coil.

If you have difficulty Pinpointing the target, or if the detector becomes too noisy when Pinpoint is turned On, turn Off Pinpoint and then return to Step 1 and repeat the Pinpoint procedure.

Pinpoint *(Continued)*

LOCATE A TARGET MANUALLY

It is possible to locate a target successfully without using Pinpoint, however this requires practice. This method may be required when a desirable target is surrounded by trash.

1. Sweep the coil slowly across the target location keeping the coil parallel to the ground.
2. Locate the centre of the target by listening for the loudest target signal response.
3. Make a mental note of the position, or mark a line on the soil with your shoe or a digging tool.
4. Move to one side so that you can pass the coil over the target at right angles to your initial direction.
5. Repeat steps 1 and 3 from your new position. The target is located where the two imaginary lines cross.

1-3

Make a line where the strongest signal is heard.

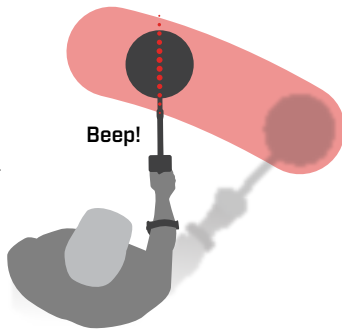

4-5

Stand at right-angles to your initial position and repeat.

The intersection of the two lines marks the exact location of the target.

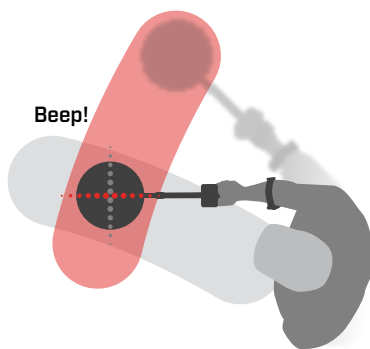

Headphones, Batteries & Charging

Wireless Headphones

ML 85 WIRELESS HEADPHONES

Minelab ML 85 Low Latency Wireless headphones are supplied with your detector. ML 85 headphones can also be used as wired headphones – see "Wired Headphones" on page 47.

For detailed information on pairing and other headphones controls and functions, refer to the instructions supplied with the headphones.

The instructions can also be downloaded at www.minelab.com/support/downloads/product-manuals-guides



Minelab ML 85 Wireless Headphones

PAIR WIRELESS HEADPHONES

1. Long-press (2 seconds) the Wireless Audio button on the detector to enter Wireless Pairing mode.



The Wireless Audio button

2. Press-and-hold the Multi Function Button (the centre button) on the ML 85 headphones until the LED flashes red and blue.
3. Your headphones will connect automatically – the Wireless Audio Indicator on the detector will remain on, and the LED on the headphones will flash blue once every 3 seconds.

If no connection is made within 5 minutes, Wireless Audio will automatically turn Off.

RE-CONNECT PREVIOUSLY PAIRED HEADPHONES

Previously paired headphones automatically re-connect.

1. Press the Wireless Audio button to turn Wireless On.



The Wireless Audio button

2. Press the Multi Function Button (the centre button) on the ML 85 headphones to turn them On.
3. The headphones will re-connect automatically.

WIRELESS AUDIO INDICATOR

The Wireless Audio Indicator appears on the display when Wireless Audio is On. It displays the current Wireless Audio connection status depending on its display state.



The Wireless Audio Indicator

Rapid flashing: Wireless Pairing mode is enabled and searching for nearby wireless headphones.

Solid on: Wireless headphones are paired and connected.

Slow flashing: Attempting to re-connect to headphones that were previously paired.

Wired Headphones

The ML 85 wireless headphones come with an auxiliary cable that allows the headphones to be used as wired headphones.



Minelab ML 85 Wireless Headphones with auxiliary cable connected.

Any standard 3.5 mm (1/8-inch) headphones can also be connected to EQUINOX, however the headphone connector overmold must be less than 9 mm (0.35") in diameter, otherwise the connector will not fit inside the waterproof socket.

CONNECT WIRED HEADPHONES

1. Unscrew the plastic dust-cap from the headphone socket on the rear of the Control Pod. If it is tight, it can be loosened with a small coin.
2. Plug the headphones into the headphone socket.
 -  The Headphone icon will appear on the top right of the detector LCD.

 When headphones are not in use, make sure that the waterproof dust-cap on the rear of the Control Pod is screwed firmly into place.

6.35 mm (1/4-inch) headphones can be used with EQUINOX via a headphone adaptor, available as an accessory.

CONNECT WATERPROOF HEADPHONES

Both EQUINOX 700 and 900 are waterproof, and can be fully submerged to a depth of 5 metres (16 feet).

Minelab EQUINOX waterproof headphones must be used for underwater detecting, as they have a unique connector that forms a waterproof seal when used with your EQUINOX.



1. Unscrew the plastic dust-cap from the headphone socket on the rear of the Control Pod. If needed, it can be loosened with a small coin.
2. Make sure that the headphone socket and connector are dry and free from sand, dust, and dirt.
3. Plug the headphones into the socket on the back of the Control Pod.
4. Carefully align the retaining ring over the connector thread and screw them together, making sure no cross-threading occurs.
 -  The Headphone icon will appear on the top right of the detector LCD.
5. Lightly tighten the retaining ring.

HEADPHONE SOCKET SUBMERSION

Before detecting underwater without headphones, **always** make sure the waterproof dust-cap is securely fitted to the Headphone Socket.

While the uncovered Headphone Socket is waterproof and can be submerged without immediately damaging the internal electronics of the detector, it can cause corrosion of the socket and false headphone detection.

 Whenever the Headphone Socket has been submerged, follow all advice listed in "[Headphone Socket Maintenance](#)" (page 56).

Batteries and Charging

CHARGER INFORMATION AND SAFETY

EQUINOX Series detectors are supplied with a USB charging cable with a snap-on magnetic connector.

The charge time from completely flat to 100% is approximately 5 to 6 hours when a high capacity (> 2A @ 5V) charger is used. A range of charging accessories are available for separate purchase.

Any standard USB port compatible with USB battery charging can be used to charge your battery, however charge times may be longer if using lower-power ports or chargers.

CAUTION: Charge your detector with a good-quality USB charger that has a minimum charging capacity of 2A @ 5V. Risk of USB charger failure if a low-quality charger is used.

Look for the following marks on USB chargers:



CAUTION: Only charge the detector in ambient temperatures between 0°C and +40°C (+32°F and +104°F).

CAUTION: DO NOT use the detector underwater whilst charging or when connected to a power bank.

NOTICE: Minelab Metal detectors and accessories are not intended to be operated while connected to a mains (AC) charger.

i Going detecting with a fully charged battery is recommended. Typical battery runtime is approximately 12 hours.

CHARGING THE BATTERY

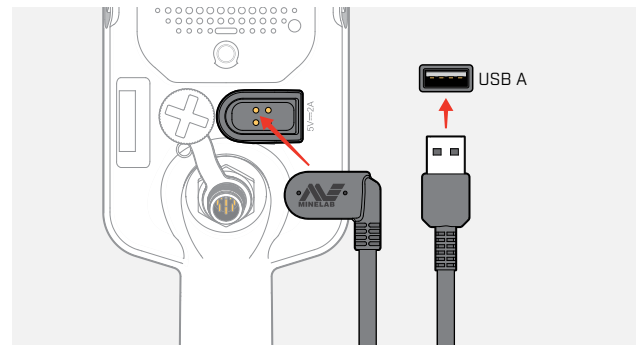

If the detector is powered On during charging, the charge time will be longer.

1. Plug the supplied charging cable into any standard powered USB-A port.
2. Connect the magnetic connector to the charging interface on the rear of the Control Pod.



3. The battery will begin to charge. To view the charging progress, refer to either the Charge Status LED (if charging while the detector is Off), or the Battery Level indicator in the Status Bar (if charging while the detector is On).

Charge Status LED

-  Charging (flashing)
-  Fully charged (on)

Batteries and Charging *(Continued)*

BATTERY LEVEL INDICATION

The Battery Level indicator shows the current battery level.



The Battery Level Indicator (fully-charged state shown)



The detector regulates the battery voltage so that detector performance remains constant regardless of the battery level.

Automatic Shut-Down



When the battery level is critically low, 'bf' will appear on the Target ID Display. The detector will then shut down automatically.

See "[Critically Low Battery Error](#)" on page 51 for steps to resolve this error.

OPERATING WITH A POWER BANK



CAUTION: The detector must not be used underwater whilst charging or when connected to a power bank.

You can use your EQUINOX detector whilst plugged into a portable power bank. This means you can continue detecting even if the detector battery is flat.

Connect the power bank to your detector using the supplied EQUINOX USB charging cable, and continue detecting.

BATTERY MAINTENANCE

See "[Battery Maintenance](#)" on page 56.

Errors & Troubleshooting

Error Codes

Some detector faults will display an Error Code on the Target ID Number field. Try the recommended actions listed before contacting an Authorised Service Centre.

COIL DISCONNECT ERROR



'Cd' is displayed in the event of a Coil Disconnect Error.

In the event of a Coil Disconnect Error, follow these steps:

1. Check that the coil connector is connected properly at the back of the Control Pod.
2. Check the coil cable for damage.
3. Check the coil for visible signs of damage.
4. Try another coil, if you have one available.

SYSTEM ERROR

System Error Code 'Er' will be accompanied by an Error Code number shown on the Frequency Display. The detector will shut down 5 seconds after reporting a system error.



'Er' is displayed in the event of a System Error.

In the event of a System Error, follow these steps:

1. Restart the detector to determine if the error still remains.
2. Confirm the coil is attached correctly.
3. Perform a Factory Reset by powering Off the detector, then press-and-hold the Power button until 'FP' appears on the Target ID Display.
4. If the error still remains, return the detector to your nearest Authorised Service Centre for repair.

CRITICALLY LOW BATTERY ERROR

When the battery level is critically low, 'bF' will appear on the Target ID Display. The detector will shut down 5 seconds after reporting a Critically Low Battery Error.



'bF' is displayed in the event of a Critically Low Battery Error.

In the event of a Critically Low Battery Error, follow these steps:

1. Recharge the battery or Connect a USB power bank.
2. Contact an Authorised Service Centre to replace the internal battery.

General Troubleshooting

Try the recommended actions listed, in order, before contacting an Authorised Service Centre.

Detector does not turn On, or turns Off by itself (with or without the 'bF' Error Code)

1. Check that the Coil is connected.
 2. Charge the detector.
 3. Check that the detector is charging and the green Charge Status LED is flashing.
 4. Check that you are charging from a USB charging source with a 2A @ 5V charging capacity.
 5. Check that the magnetic connector and Charging Interface on the back of the Control Pod are clean and free of debris.
 6. Check that the USB charging cable is properly seated/connected to the detector.
-

Erratic and/or excessive noise

1. Move away from local sources of Electromagnetic Interference (EMI).
 2. Perform an Auto Noise Cancel.
 3. Perform a Ground Balance.
 4. Reduce the Sensitivity Level.
-

No sound – Wired headphones

1. Check that the detector is On, and start-up has completed.
 2. Check that the headphones are plugged in and fully inserted into the Headphone Socket.
 3. Check that the Headphones indicator is displayed in the Status Bar.
 4. Check that Volume is set to an audible level.
 5. Unplug the headphones and confirm that the detector Speaker is audible.
 6. Check that the headphones connector is free of moisture or debris.
 7. If available, try using a different set of headphones.
-

No sound – ML 85 Headphones

1. Check that the headphones are turned On.
 2. Check that detector Wireless is turned On and paired with headphones (i.e. the Wireless indicator is steady On).
 3. Check that the headphones are charged.
 4. Check that the detector Volume is set to an audible level.
 5. Check the volume control on the headphones is set to an audible level.
 6. Pair the detector to a different set of compatible wireless headphones.
 7. Try wired headphones.
-

ML 85 Headphones will not pair

1. Try powering Off the ML 85 headphones and then re-pair.
 2. Ensure the headphones are within 1 metre (3 feet) of the detector Control Pod, with no obstructions between the headphones and detector (including your own body).
 3. Move away from sources of interference such as mobile phones.
 4. If there are many other wireless devices nearby, pairing may take longer. Move away from the area and try to pair again.
 5. Factory Reset the headphones and attempt to re-pair to the detector.
 6. Pair the detector to a different set of compatible wireless headphones, then attempt to re-pair the ML 85 headphones to the detector.
-

Distortion/crackling heard in ML 85 Headphones when connected via Wireless

1. Ensure the headphones are within 1 metre (3 feet) of the detector Control Pod, with no obstructions between the headphones and detector (including your own body).
-

General Troubleshooting *(Continued)*

Master Vibration is turned On, but there is no vibration

1. Check that Master Vibration is turned On.
 2. Check that Vibration is turned On for at least one Tone Region.
-

Detector is charging and the Charge Status LED is flashing, but the charge indicator is missing in the Status Bar

1. Check that you are charging from a USB charging source with a 2A @ 5V charging capacity.
 2. If charging from a lower-powered USB port (such as a laptop port), the detector may be discharging the battery at a faster rate than it is charging. This prevents the charge indicator from appearing. Try charging with the detector switched off.
 3. Avoid using a USB extension cable when charging.
-

Speaker is squeaky or muffled after submersion in cold water

1. Allow up to 30 minutes for the detector internal air pressure to return to normal. Note, laying the detector on the ground with the Control Pod standing up may equalise internal air pressure faster.
-

Headphone indicator is On, but no headphones are connected

There may be water inside the Headphone Socket causing false detection of wired headphones.

1. Check that the Headphone Socket is clear of water and obstructions.
 2. If water is present, use a warm (not hot) air dryer to dry the Socket.
-

Safety, Care and Maintenance

Detector Care and Safety

GENERAL CARE AND SAFETY

- Wash your hands before handling the detector when using sunscreen or insect repellents.
- The Display lens is made from quality optical plastic for clear viewing of the screen and is therefore prone to scratching or serious damage if not treated with due care. Application of the supplied screen protector is strongly recommended. Replace it periodically if it becomes scuffed or scratched.
- Never clean the Display lens using solvents or alcohol-based cleaners. To clean the Display lens, use a slightly damp cloth with mild soap detergent. Dry with a clean lint-free cloth to remove water-spots.
- Do not use any lubricants, sealants, or solvent or alcohol-based cleaners on any part of your detector. Even chemicals typically considered mild such as isopropyl alcohol or silicone lubricants can degrade material properties or the integrity of seals. Use of chemicals on the product may void the warranty. To clean, use a slightly damp cloth with mild soap detergent.
- Do not submerge the detector in water with the Control Pod disassembled from the shaft, as the battery compartment is only waterproof when assembled to the supplied shaft. Note also that the use of after-market shafts prevents the battery compartment from sealing correctly, causing it to leak/become damaged.
- Do not allow the detector to come into contact with gasoline/petrol or other petroleum-based liquids.
- Do not bring the detector or accessories into contact with sharp objects as this may cause scratches and damage.
- Avoid getting sand and grit in any moving parts including the Shafts, Camlocks and Yoke assembly. If sand and grit accumulates in these parts they should be rinsed in fresh water then dried thoroughly.
- Prior to going detecting, check that the Camlocks are gripping the Shafts tightly and do not slip. Follow the advice listed in "[Maintenance of Parts](#)" – "[Tightening the Camlocks](#)" (page 56).
- Do not expose the detector to extreme temperature conditions. The storage temperature range is from -20°C to +70°C (-4°F to +158°F). Avoid leaving it inside a vehicle parked in the sun on a hot day, as temperatures can reach extreme levels.
- Ensure the Coil Cable is kept in good condition, free of strain, kinks and tight bends.
- Do not expose accessories not listed as waterproof to liquid/moisture or excessive humidity.
- Do not allow small children to play with the detector or accessories, small parts are a choking hazard.
- Only charge the detector and accessories according to the instructions provided.
- Do not charge the detector or accessories in extreme temperature conditions – Only charge the detector in ambient temperatures between 0°C and +40°C (+32°F and +104°F).
- Do not use tools to tighten the Coil Connector to the Control Pod, this will damage the Control Pod. If the Coil Connector is not fitting easily, flush any dirt/grit away with fresh water then allow it to dry before trying again.
- Do not attempt to adjust the Coil Connector nut on the back of the Control Pod. This is locked in place and tampering will damage the Control Pod.
- Do not poke sharp objects into the Speaker grille to clean it, this will damage the Speaker and compromise waterproofing. Clean the Speaker by flushing fresh water through the grille.

Detector Care and Safety *(Continued)*

MAINTENANCE OF PARTS

Tightening the Camlocks

The plastic parts of the Camlock stretch slightly during normal use and may need tightening periodically (every few months of regular use), or when the detector has not been used within a month or more.

1. Open the Camlock.



2. Gently tighten the thumbscrew in small increments.



3. Close the Camlock.

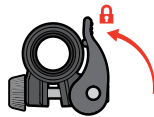

4. Check after adjustment by applying normal force to the shafts.

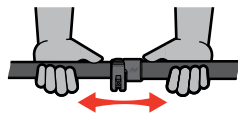

5. Repeat until the shafts do not collapse easily under normal force.

⚠ Take care not to over-tighten the thumbscrew, this may damage the camlock parts.

Battery Maintenance

Lithium-ion battery performance may degrade if unused for long periods of time. Fully charge the battery at least once every 3 to 4 months to prevent this from occurring.

Even with correct care and maintenance, Lithium-ion battery performance reduces over time with normal use. Therefore the battery may need to be replaced every few years. Replacement batteries can be supplied and installed by a Minelab Authorised Service Centre.

⚠ Do not apply any chemicals including O-ring lubricant, grease or silicon grease to seals or O-rings if replacing the internal battery, as this will damage the battery seal.

Coil Maintenance

The Skidplate is a sacrificial/replaceable part intended to protect the Coil from damage. Replace the Skidplate when it becomes excessively worn, but before it wears through in any place.

After Beach/Saltwater Detecting

Sand is abrasive, and salt can corrode metal parts of the detector over time. Following the listed advice is essential to avoid damage to parts of your detector.

Removing Sand From the Detector

Immediately after detecting at the beach or in saltwater, rinse all parts of the detector with fresh water. Avoid wiping the detector to remove sand as this may cause the sand to scratch the detector.

Open both Camlocks and flush with clean fresh water.

Headphone Socket Maintenance

Immediately after underwater detecting sessions, make sure that the area around the connector is dry and free of sand/mud **before** disconnecting the headphones (or the waterproof dust-cap).

If any sand/mud accidentally gets inside the Headphone Socket, flush it gently with fresh water before drying it thoroughly.

ML 85 Headphones Maintenance

For ML 85 Care and Safety, refer to the Instructions Supplied with the headphones. The instructions can also be downloaded at www.minelab.com/support/downloads/product-manuals-guides.

Specifications, Presets & Compliance





Technical Specifications

	EQUINOX 700	EQUINOX 900
Search Modes	Park, Field, Beach	Park, Field, Beach, Gold
All-Metal Shortcut	Yes	
Custom Search Profiles	6	8
User Profile Button	No	Yes
Operating Frequencies (kHz)	Multi, 4, 5, 10, 15	Multi, 4, 5, 10, 15, 20, 40
Noise Cancel	Auto (19 Channels)	Auto (19 Channels), Manual
Ground Balance	Auto, Manual, Tracking	
Sensitivity	1 to 25	1 to 28
Target Volume	0 to 25	
Threshold Level	0 to 25	
Threshold Pitch	Fixed	0 to 25
Target Identification (TID)	119 segment notch discrimination: Ferrous: -19 to 0 Non-ferrous: 1 to 99	
Target Tones	1, 2, 5, All Tones (At), Depth (dP)	
Tone Break	Ferrous (t1)	Ferrous, Non-ferrous (t1, t2, t3, t4)
Tone Pitch	Tone 1 adjustable: 0 to 25	All tones adjustable: 0 to 25
Tone Volume	Tone 1 adjustable: 0 to 25	All tones adjustable: 0 to 25
Recovery Speed	1 to 3	1 to 8
Iron Bias	-1 to 3	-1 to 9
Depth Indicator	5 levels	5 levels
Discrimination Segments	119 segments	119 segments
Pinpoint Mode	Yes	
Wireless Audio	Yes	
Length (approx.)	Collapsed: 61 cm (24 in) Extended: 144 cm (56.7 in)	
Weight	1.27 kg (2.8 lbs)	
Display	Monochrome LCD	
Display and Keypad Backlight	Red Off, High, Low	Red Off, High, Medium, Low
Flashlight	On, Off	
Vibration	On, Off	
Supplied Coil	EQX11 11" Double-D coil with skid plate	EQX11 11", EQX06 6" Double-D coils with skid plate
Audio Output	In-built loudspeaker, Wired 3.5 mm (1/8") headphones, Wireless headphones	
Supplied Headphones	Minelab ML 85 Low Latency wireless headphones	
Battery	3.7V/5100 mAh Internal Lithium-Ion battery	
Additional Included Accessories	Getting Started Guide, Screen Protector (English), Charging Cable	
Waterproof	Waterproof to 5 m / 16 ft, IP68	
Operating Temperature Range	-10°C to +40°C (+14°F to +104°F)	
Storage Temperature Range	-20°C to +70°C (-4°F to +158°F)	
Key Technologies	Multi-IQ®	
Warranty	Register your product warranty online at register.minelab.com . Full warranty terms and conditions are available to download at www.minelab.com/support/product-warranty .	













Equipment may vary according to the model or items ordered with your detector. Minelab reserves the right to respond to ongoing technical progress by introducing changes in design, equipment and technical features at any time. For the most up-to-date specifications for your EQUINOX detector, visit www.minelab.com.

Default Settings

General Settings (Global)

 Volume Adjust	20
 Sensitivity	20
 Backlight	Off
 Flashlight	Off
 Vibration	Off

Search Mode Profiles

	Park 1	Park 2	Field 1	Field 2	Beach 1	Beach 2	Gold 1*	Gold 2*
 Frequency	Multi		Multi		Multi		Multi	
 Noise Cancel	0		0		0		0	
 Ground Balance	Manual, 0		Manual, 0		Manual, 0		 Tracking	
 Tone Volume	12, 25, 25, 25, 25	12, 25	4, 25	4, 25	4, 25, 25, 25, 25		12	
 Threshold Level	0		0		0		12	
 Threshold Pitch*	4		4		4		11	
 Target Tone	5	All Tones (At)	2	All Tones (At)	5		1	
 Tone Pitch	1, 6, 12, 18, 25	1, 20	1, 20	1, 20	1, 6, 12, 18, 25		—	
 Accept/Reject	✗ -19 to 2 ✓ 3 to 99	✗ -19 to 0 ✓ 1 to 99	✗ -19 to 4 ✓ 5 to 99		✗ -19 to 0 ✓ 1 to 99		✗ -19 to 0 ✓ 1 to 99	
 Tone Break	0, 20, 56, 84	0	4	4	0, 20, 56, 84		—	
 Recovery Speed	2/4*	3/5*	3/5*	3/6*	3/6*	3/6*	5*	5*
 Iron Bias	2/4*	1/2*	1/2*	0/0	3/6*	3/6*	4*	4*

* EQUINOX 900 only

Default Settings *(Continued)*

Advanced Audio Setting Defaults

	Park 1	Park 2	Field 1	Field 2	Beach 1	Beach 2	Gold* 1	Gold* 2
🔊 Tone Volume								
1 Tone	25		25		25		25	
2 Tones	12, 25		4, 25		4, 25		—	
5 Tones	12, 25, 25, 25, 25		4, 25, 25, 25, 25		4, 25, 25, 25, 25		—	
All Tones (At)	12, 25		4, 25		4, 25		—	
Depth (dP)	12, 25		4, 25		4, 25		—	
🔊 Tone Pitch								
1 Tone	11		11		11		—	
2 Tones	1, 20		1, 20		1, 20		—	
5 Tones	1, 6, 12, 18, 25		1, 6, 12, 18, 25		1, 6, 12, 18, 25		—	
All Tones (At)	1, 20		1, 20		1, 20		—	
Depth (dP)	1, 20		1, 20		1, 20		—	
🔊 Tone Break								
2 Tones	0		5		0		—	
5 Tones	0, 25, 50, 75		5, 25, 50, 75		0, 25, 50, 75		—	
All Tones (At)	0		5		0		—	
Depth (dP)	0		5		0		—	

* EQUINOX 900 only

Factory Reset

The Factory Reset function returns all detector settings, Search Modes, and Discrimination Patterns to their Factory Preset state.

1. Ensure the detector is powered Off.
2. Press-and-hold the Power Button until 'FP' appears on the Target ID Display.



'FP' will appear on the Target ID display when Factory Presets are restored.

Software Updates

EQUINOX Series detectors contain software that can be updated via the supplied USB charging/data transfer cable.

Visit www.minelab.com/support for up-to-date EQUINOX Software and installation instructions.

DOCUMENT USAGE RIGHTS

This work is licensed under the Creative Commons Attribution-NonCommercial-NoDerivatives 4.0 International (CC BY-NC-ND 4.0) International License. To view a copy of this license, visit: <http://creativecommons.org/licenses/by-nc-nd/4.0/>



DISCLAIMER

The Minelab metal detector described in this instruction manual has been expressly designed and manufactured as a quality metal detector and is recommended for treasure and gold detecting in non-hazardous environments. This metal detector has not been designed for use as a mine detector or as a live munitions detection tool.

MINELAB®, EQUINOX®, Multi-IQ®, EQX06™, EQX11™, and EQX15™ are trademarks of Minelab Electronics Pty. Ltd.

COMPLIANCE

To view product compliance information, navigate to the Noise Cancel setting, then press-and-hold the All Metal button.



Refer to the included *Instructions and Safety Information* leaflet for further regulatory information.





www.minelab.com

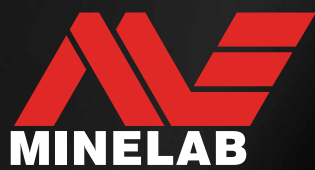

4901-0-418-3

