

Field Guide

F3 UXO Detector

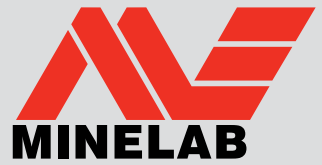

Operation

1.
Switch On

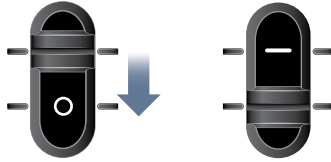
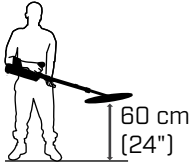

12 seconds

2.
Ground
Balance

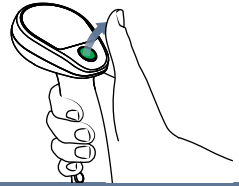
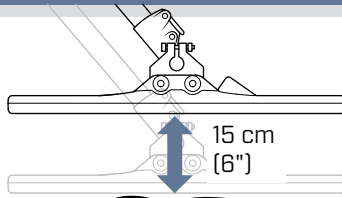
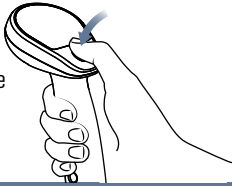

3.
Test Piece

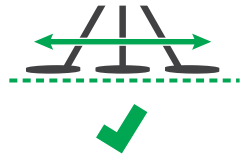
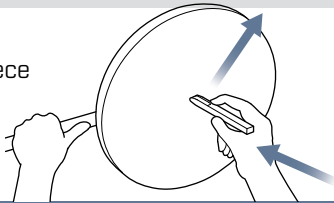

4.
Audio Reset

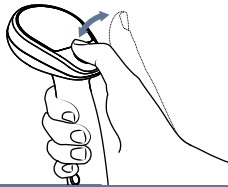

5.
Noise Cancel

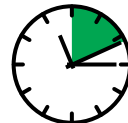
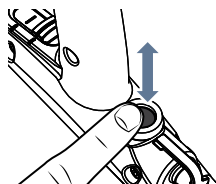
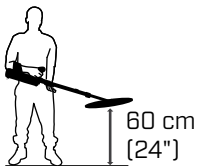
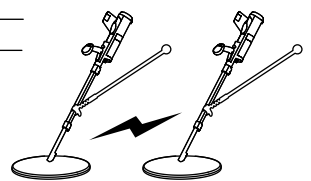
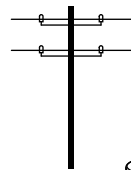

45 seconds

F3 UXO Configuration

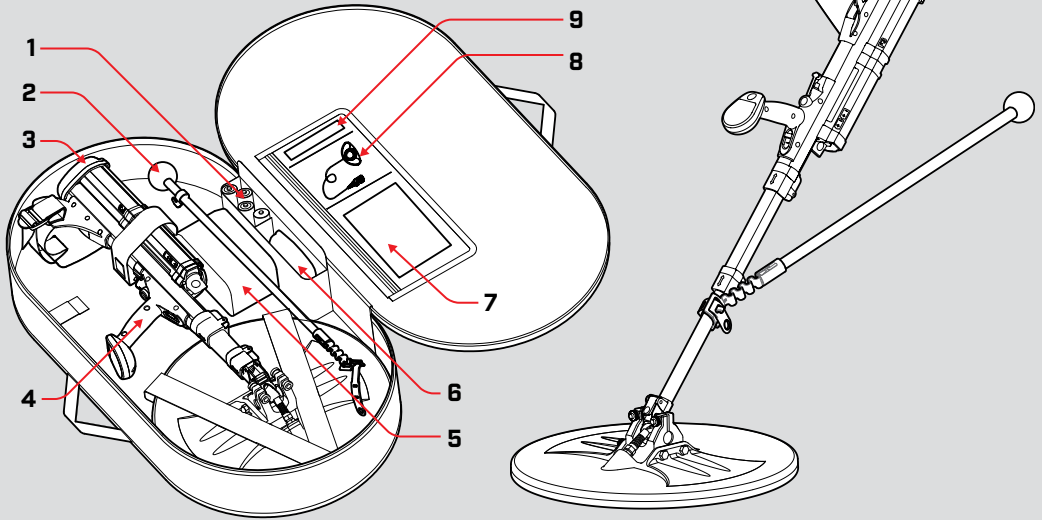

- | | |
|--|---|
| 1. Batteries 4 × D Cell | 6. Red Endcap (Yellow Endcap Optional) |
| 2. Guide Arm | 7. Field Guide, Interchange Procedure and Operations Manual |
| 3. Black Endcap (Default) | 8. Earset |
| 4. F3 UXO Detector | 9. Test Piece |
| 5. Battery Pack Bag and Extension Cable (Optional) | |

Guide Arm Assembly

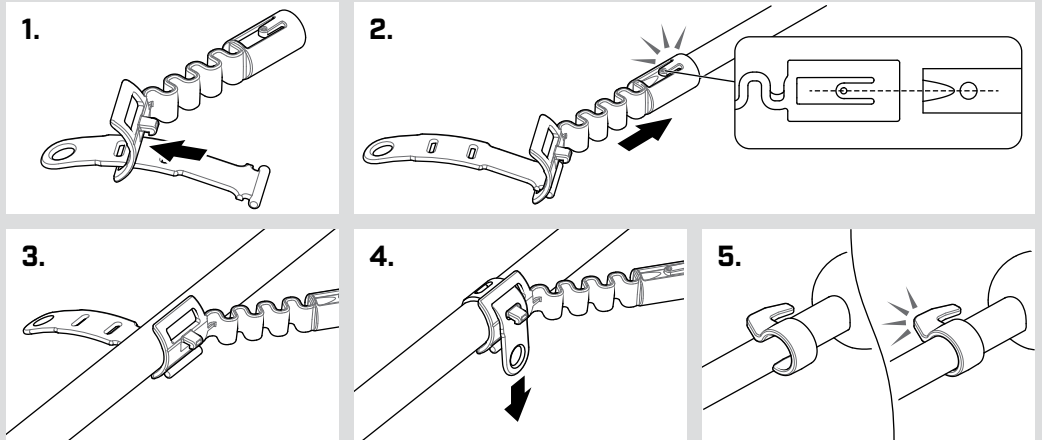

F3 Endcap Guide



Black
High Sensitivity
(Default Endcap)



Red
Reduced Sensitivity



Yellow
Detector Settings Customisable Via PC